

DO NOT SCALE

IF IN DOUBT ASK



Revisions

Rev Description Date Approved

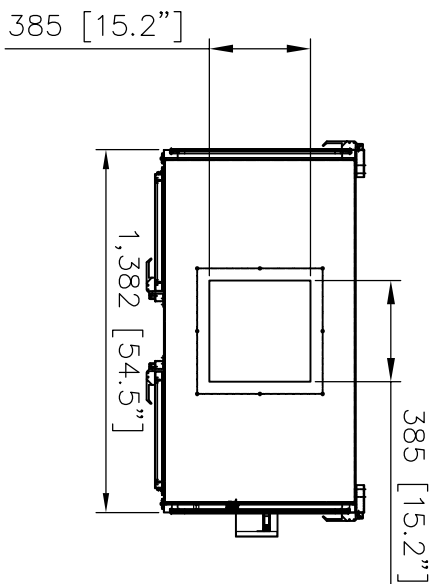
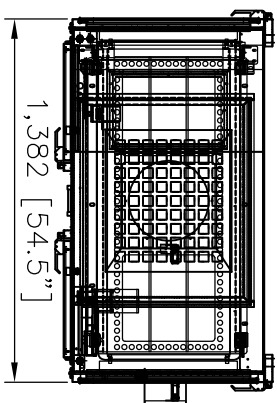

Inlet: dia. 12"
Outlet: dia. 14"

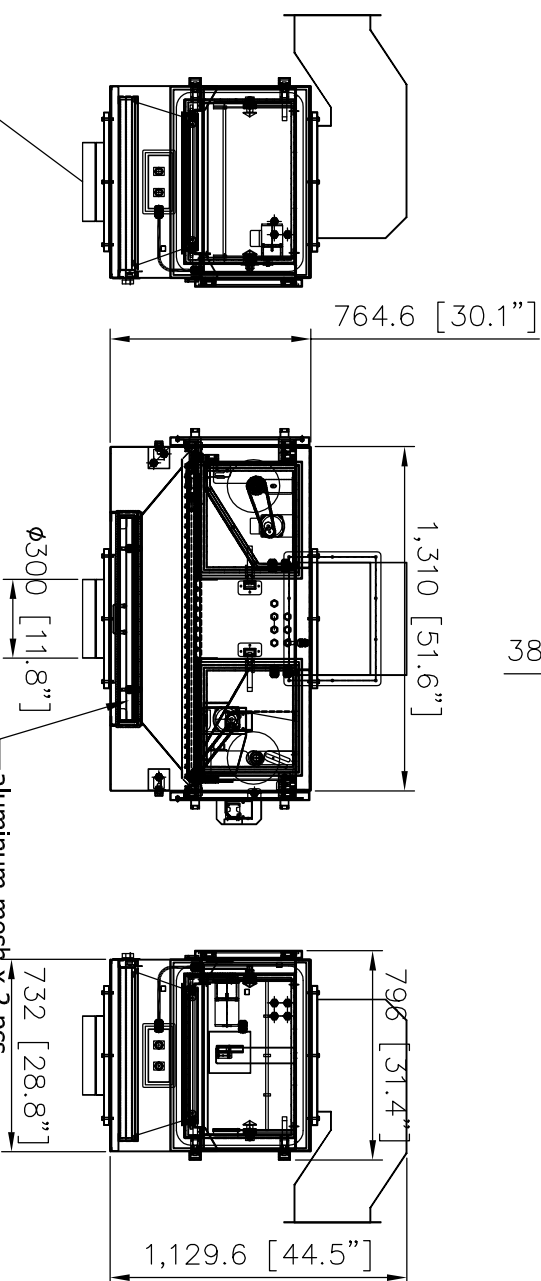

aluminum mesh x 2 pcs
stainless net x 1 pc

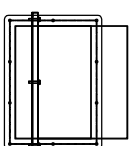
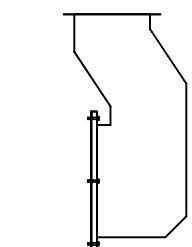
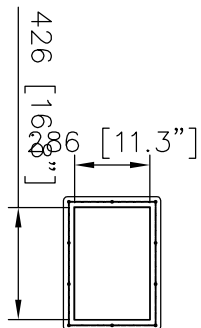
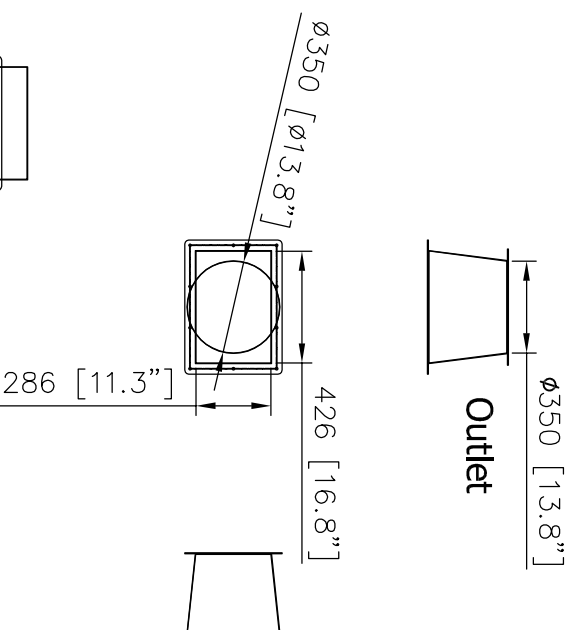
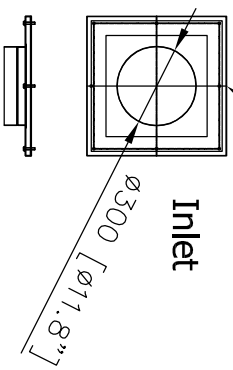

AVANI ENVIRONMENTAL INTL. INC. Sales Department
95 Cypress Drive (919) 570-2862
Youngsville, NC 27596 info@avanienvironmental.com

Date Name Part Number: Title: Roll Media RM-4000-B

Drawn by: 2013-01-16 ***

Checked by: 2013-01-15 ***

Size Scale Drawing Number: B 1 = 16 wall-mounted

The drawings, AutoCAD, 3-D Models, and specifications are the property of Avani Environmental Intl. Inc. (AE) and may not be reproduced, distributed, modified, or otherwise used, except provided herein, without the express written permission of AE.