



Date: April 14, 2015

Project:

To: Veron

Attn:

Recommended Equipment:

- (6) Backdraft hoods: 4" x 40" x 4"
- (3) Hanging Fume Arms: 2040 (8" x 14')
- (1) Fan: DBN200 w/ 7500 CFM
- (1) Heavy Duty Single Boom: 8010 (8" x 10')
- (1) Plasma CAM system: PS-150 w/ RM-150E and DP66
- (6) Welding Booth: WB-1055 (side-by-side)
- (6) Hanging Fume Arms: 1620 (6" x 7')

Avani Environmental Intl. Inc.
95 Cypress Drive
Youngsville, NC 27596
www.avanienvironmental.com

Phone: (919) 570-2862
Fax: (919) 570-2863
Email: info@avanienvironmental.com
www.weldingbooths.com

The drawings, AutoCAD, 3-D Models, and specifications are the property of Avani Environmental Intl. Inc. (AE) and may not be reproduced, distributed, modified, or otherwise used, except provided herein, without the express written permission of AE.

DO NOT SCALE

IF IN DOUBT ASK



Revisions

Rev	Description	Date	Approved
-----	-------------	------	----------

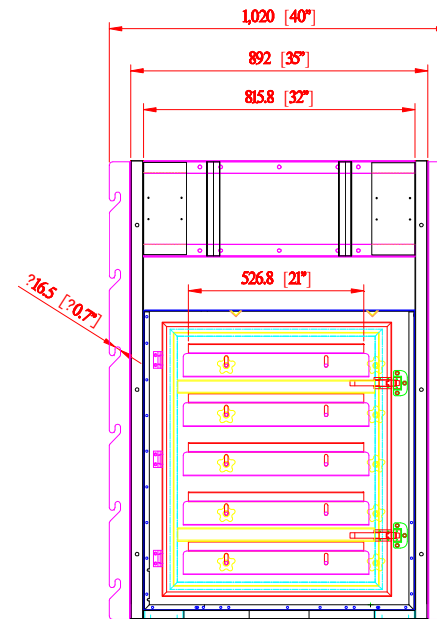
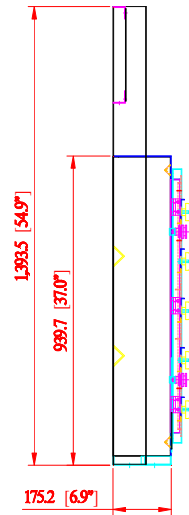
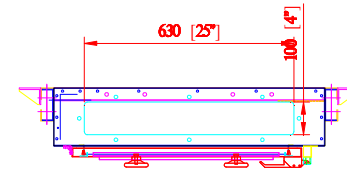
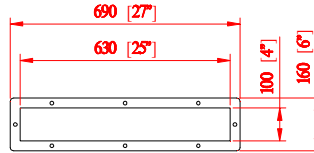
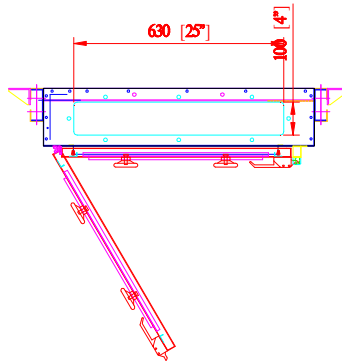

PRELIMINARY

AVANI ENVIRONMENTAL INTL. INC. Sales Department
 95 Cypress Drive (919) 570-2862
 Youngsville, NC 27596 info@avanienvironmental.com

	Date	Name	Part Number:
Drawn by:	2015-04-14	***	REVISION A
Checked by:			

Title: Backdraft Hood: 4" x 40"-C

The drawings, AutoCAD, 3-D Models, and specifications are the property of Avani Environmental Intl. Inc. (AE) and may not be reproduced, distributed, modified, or otherwise used, except provided herein, without the express written permission of AE.

Size	Scale	Drawing Number:
A	1 = 15	2 Backdraft Hood: 4" x 40"-C

DO NOT SCALE

IF IN DOUBT ASK

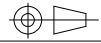

Revisions

Rev	Description	Date	Approved
-----	-------------	------	----------

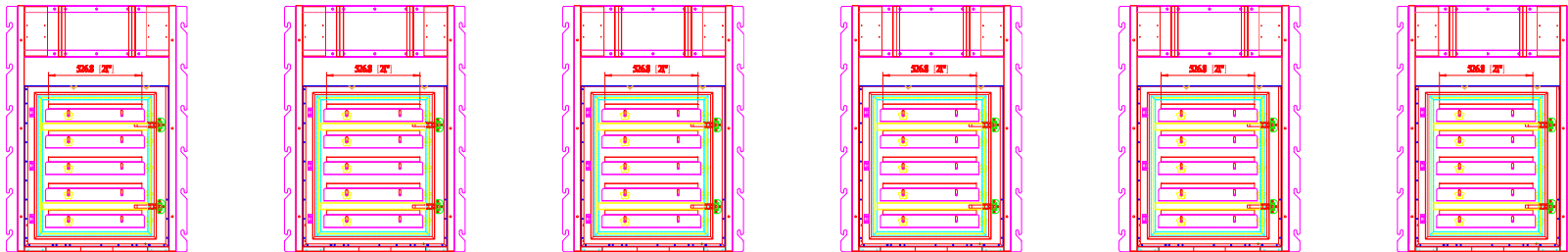
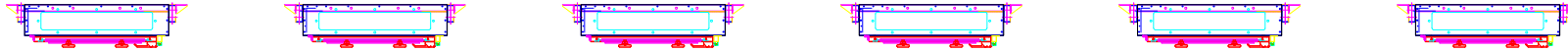

PRELIMINARY

AVANI ENVIRONMENTAL INTL. INC. Sales Department
 95 Cypress Drive (919) 570-2862
 Youngsville, NC 27596 info@avanienvironmental.com

Date	Name	Part Number:
2015-04-14	***	REVISION A
Checked by:		

Title:
Backdraft Hood: 4" x 40"-C layout

The drawings, AutoCAD, 3-D Models, and specifications are the property of Avani Environmental Intl. Inc. (AE) and may not be reproduced, distributed, modified, or otherwise used, except provided herein, without the express written permission of AE.

Size
A

Scale
1 = 15

Drawing Number:
3
Backdraft Hood: 4" x 40"-C

DO NOT SCALE

IF IN DOUBT ASK

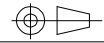

Revisions			
Rev	Description	Date	Approved

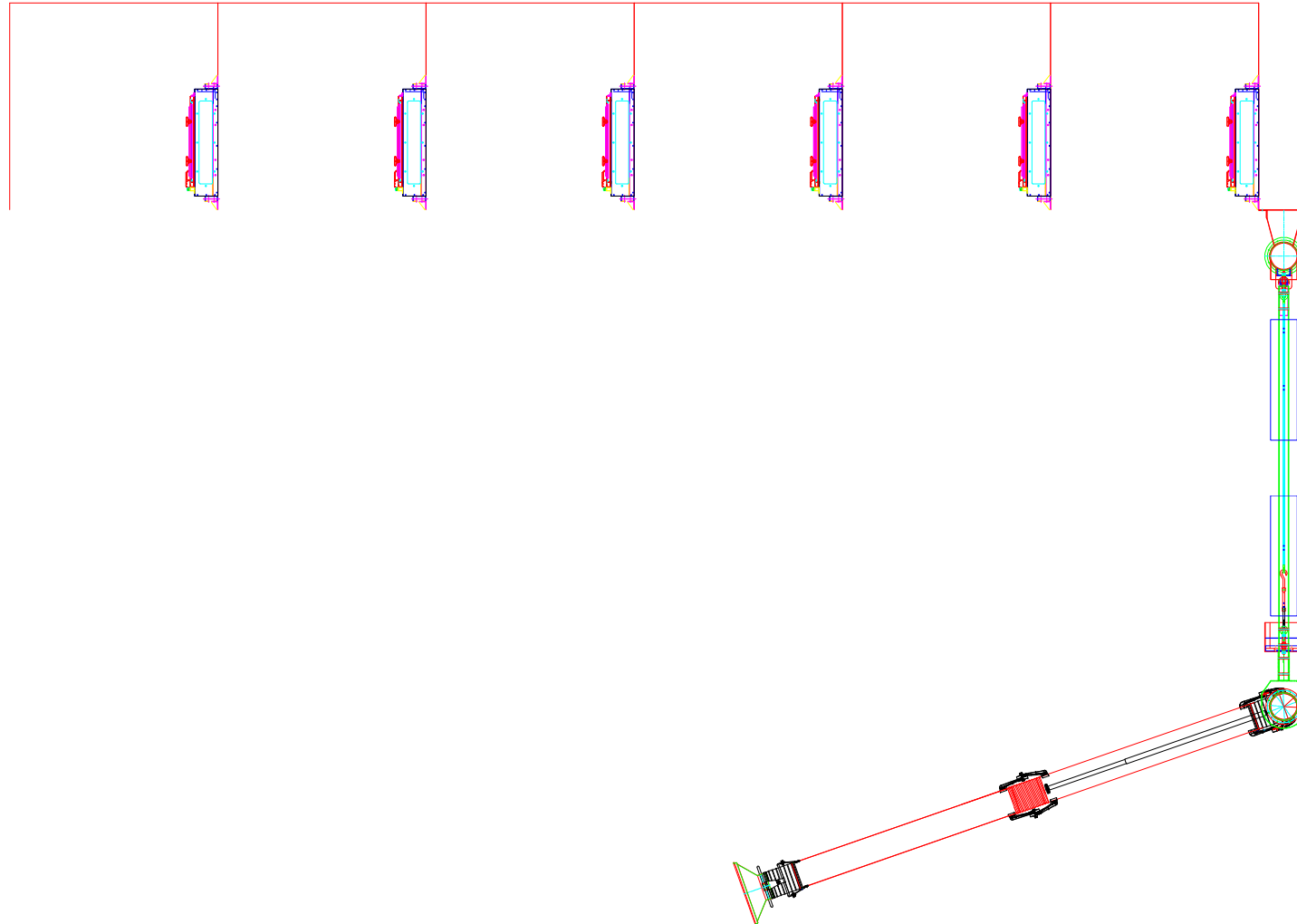

PRELIMINARY

AVANI ENVIRONMENTAL INTL. INC. Sales Department
 95 Cypress Drive (919) 570-2862
 Youngsville, NC 27596 info@avanienvironmental.com

Drawn by:	Date	Name	Part Number: REVISION A
Checked by:	2015-04-14	***	
The drawings, AutoCAD, 3-D Models, and specifications are the property of Avani Environmental Intl. Inc. (AE) and may not be reproduced, distributed, modified, or otherwise used, except provided herein, without the express written permission of AE.			

Title: Backdraft Hood: 4" x 40"-C layout		
Size A	Scale 1 = 15	Drawing Number: Backdraft Hood: 4" x 40"-C

DO NOT SCALE

IF IN DOUBT ASK

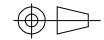

Revisions			
Rev	Description	Date	Approved

Heavy Duty Single Boom 8"*10'

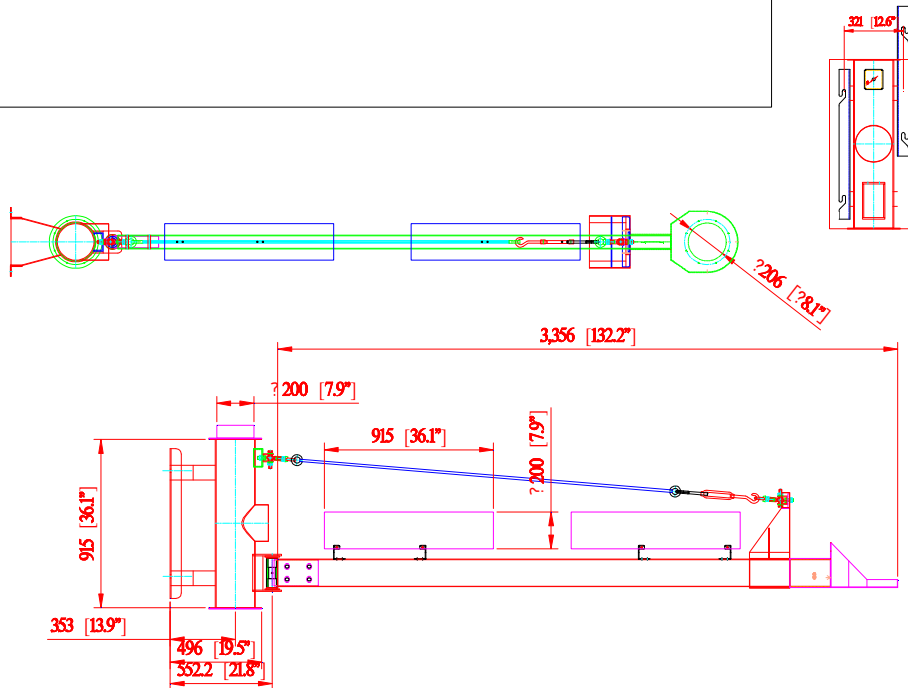
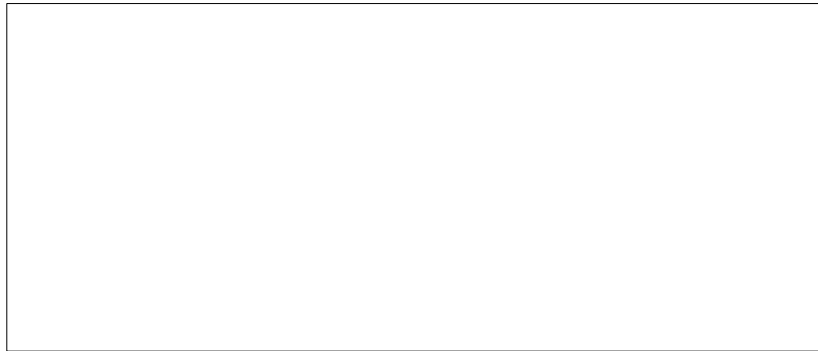

- BM-8010 SPECIFICATIONS-

- Diameter:** 8"
- Length:** 10'
- Weight:** 275.6 lbs (net)
- Boom Construction:** Two galvanized steel tubes, three pieces of flex hose at joints.
- Dual Outlet:** Ø8" x 36.1", 14 gauge steel
- Rotating-End Bronze brake plate 1:** (2) ? 2.56", 7 gauge steel
- Rotating shaft 1:** Ø1.58" x 10.39", Medium carbon steel
- Self-lubricating bushing:** (2) ? 1.73" x 1.97"
- Square tube:** L:117.79" x W:2.95" x H:5.9", 12 gauge steel
- Galvanized steel tube:** (2) Ø7.88" x 36", 14 gauge steel
- Steel Rod:** Ø0.04", Medium carbon steel
- Turnbuckle:** 5/8"
- Eyebolt:** (2) M16 x 50L
- Rod-End Bearing:** (2) PHS-16
- Fume Arm Bracket Set:** 132.2" x 13.2" x 20.4", 12 gauge steel
- Boom Adjustment:** Externally supported, adjustments are quickly done at the joints.
- Finish:** Powder coated.
- Hose:** Rated at 200°F
- Warranty:** Limited two years from date of purchase.

AVANI ENVIRONMENTAL INTL. INC. Sales Department
 95 Cypress Drive
 Youngsville, NC 27596
 (919) 570-2862
 info@avanienvironmental.com

	Date	Name	Part Number:	Title:
Drawn by:	2010-04-14	***	2009.07.14	BM-8010 (single)
Checked by:				
The drawings, AutoCAD, 3-D Models, and specifications are the property of Avani Environmental Intl. Inc. (AE) and may not be reproduced, distributed, modified, or otherwise used, except provided herein, without the express written permission of AE.				

Size	Scale	Drawing Number:
A	1 = xx	BS-2010-01A

DO NOT SCALE

IF IN DOUBT ASK



Revisions			
Rev	Description	Date	Approved

Hanging Arm 8"*14'

Diameter: 8"

Length: 14'

Weight: 79.4 lbs (net)

Arm Construction: Two galvanized steel tubes, three pieces of flex hose at joints, aluminum hood, heavy gauge steel swivel base, and support spring.

Arm Adjustment: Externally supported, adjustments are quickly done at the joints.

Hood: 14" diameter round aluminum hood.

Damper: Internal with external adjustment.

Finish: Powder coated.

Hose: Rated at 160°F

Accessories: Mounting bracket and light kit.

Mounting Bracket:

Warranty: Limited two years from date of purchase.

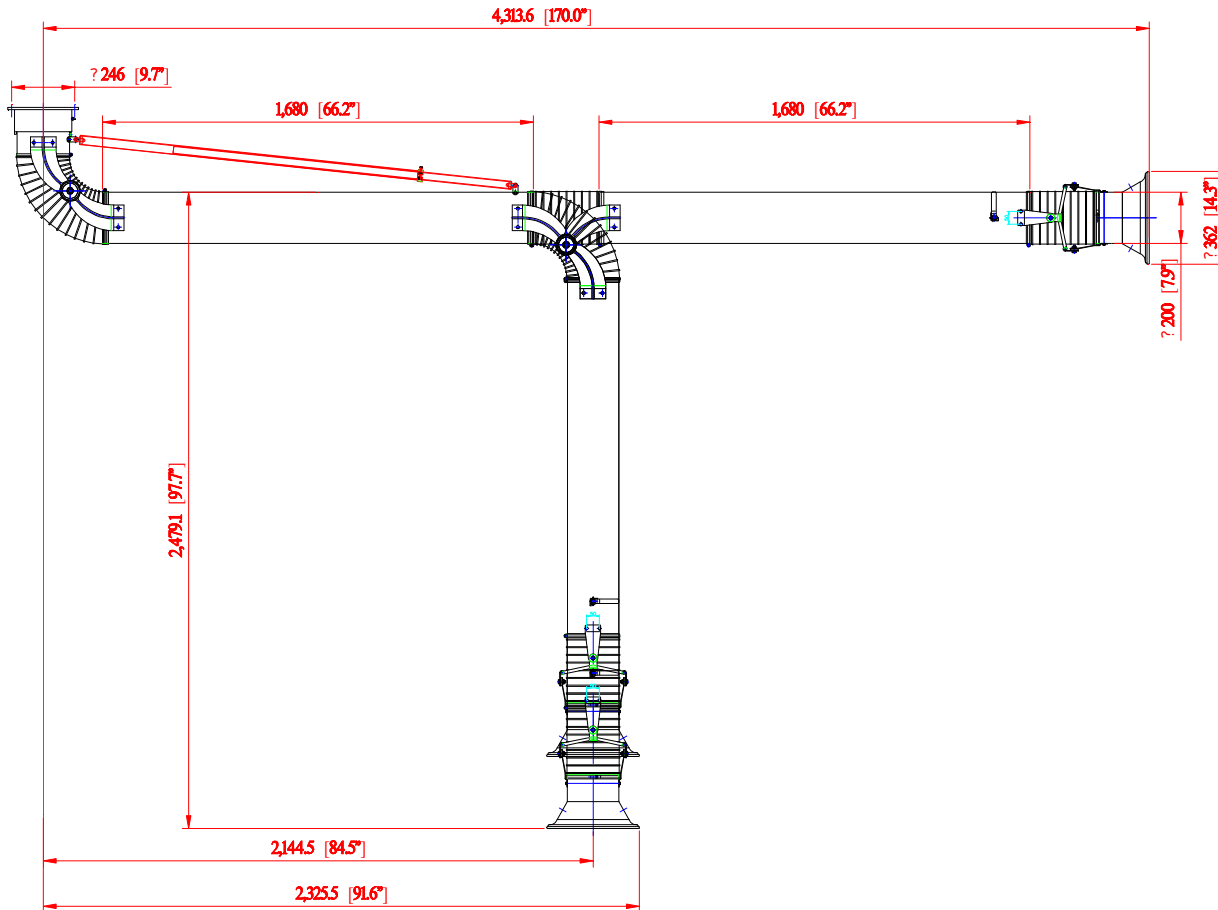

Packing Size:	246.6 x 40 x 75.5 cm 97 x 15.7 x 29.7 inch
N.W. / G.W.:	36 / 45 kgs 79.4 / 99.2 lbs

AVANI ENVIRONMENTAL INTL. INC. Sales Department
 95 Cypress Drive
 Youngsville, NC 27596

(919) 570-2862
 info@avanienvironmental.com

	Date	Name	Part Number:	Title:
Drawn by:	2010-01-29	***	**	Arm 2040
Checked by:				
The drawings, AutoCAD, 3-D Models, and specifications are the property of Avani Environmental Intl. Inc. (AE) and may not be reproduced, distributed, modified, or otherwise used, except provided herein, without the express written permission of AE.				

Size	Scale	Drawing Number:
A	1 = xx	2010.01.29

DO NOT SCALE

IF IN DOUBT ASK

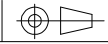

Revisions

Rev	Description	Date	Approved
-----	-------------	------	----------

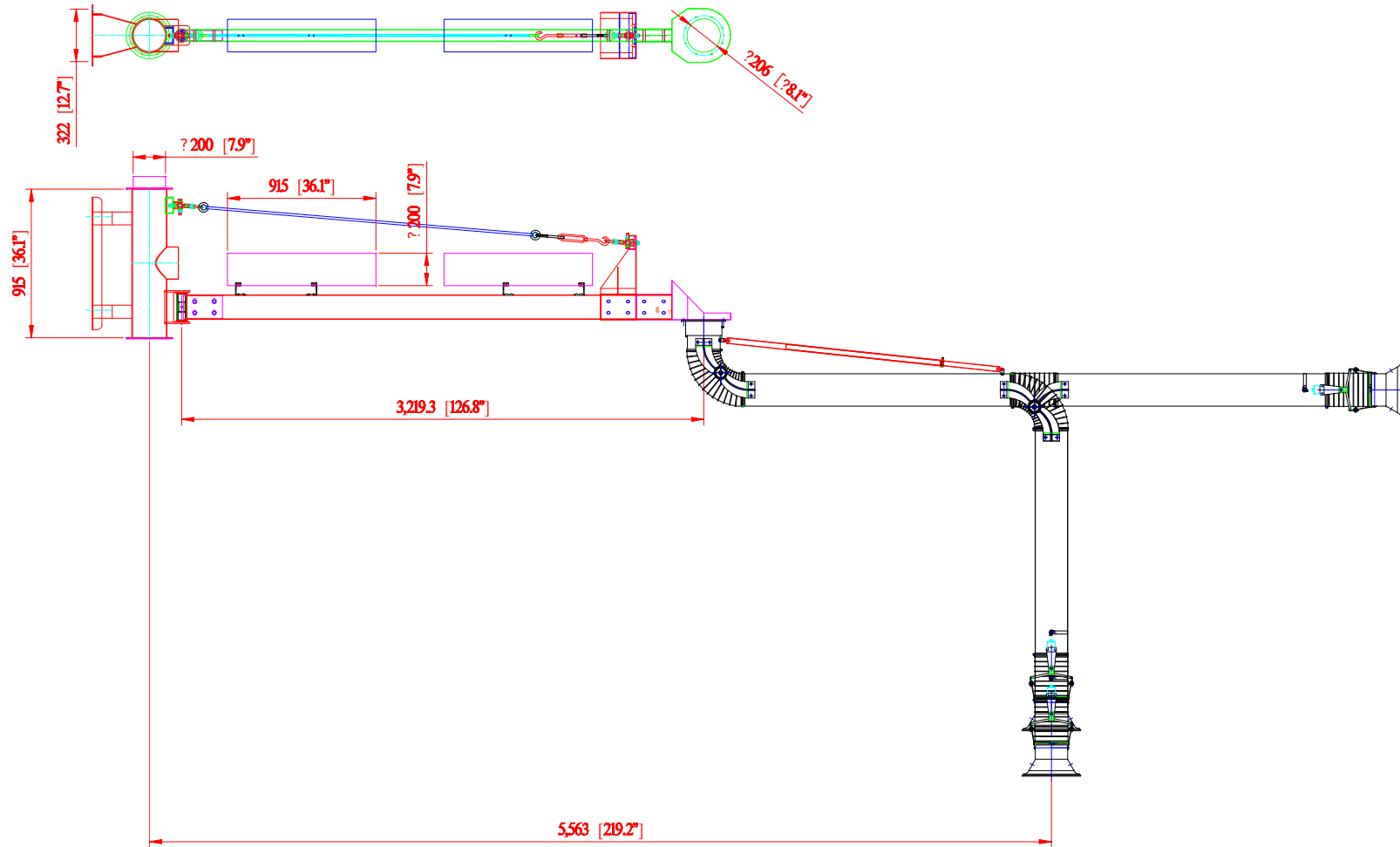

AVANI ENVIRONMENTAL INTL. INC. Sales Department
 95 Cypress Drive (919) 570-2862
 Youngsville, NC 27596 info@avanienvironmental.com

	Date	Name	Part Number:
Drawn by:	2010-04-14	***	2009.07.14
Checked by:			

The drawings, AutoCAD, 3-D Models, and specifications are the property of Avani Environmental Intl. Inc. (AE) and may not be reproduced, distributed, modified, or otherwise used, except provided herein, without the express written permission of AE.

Title:
BM-8010 (single) w/ Arm 2040

Size
A

Scale
 1 = xx

Drawing Number:
BS-2010-01A

DO NOT SCALE

IF IN DOUBT ASK



Revisions			
Rev	Description	Date	Approved

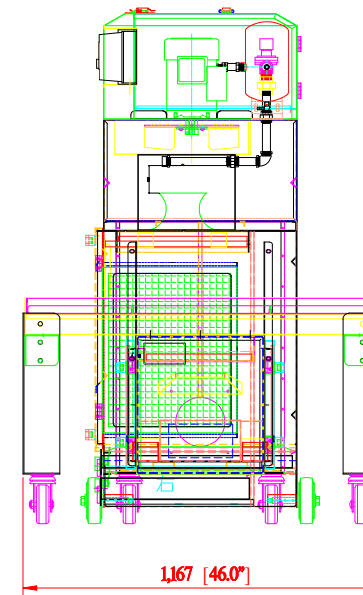
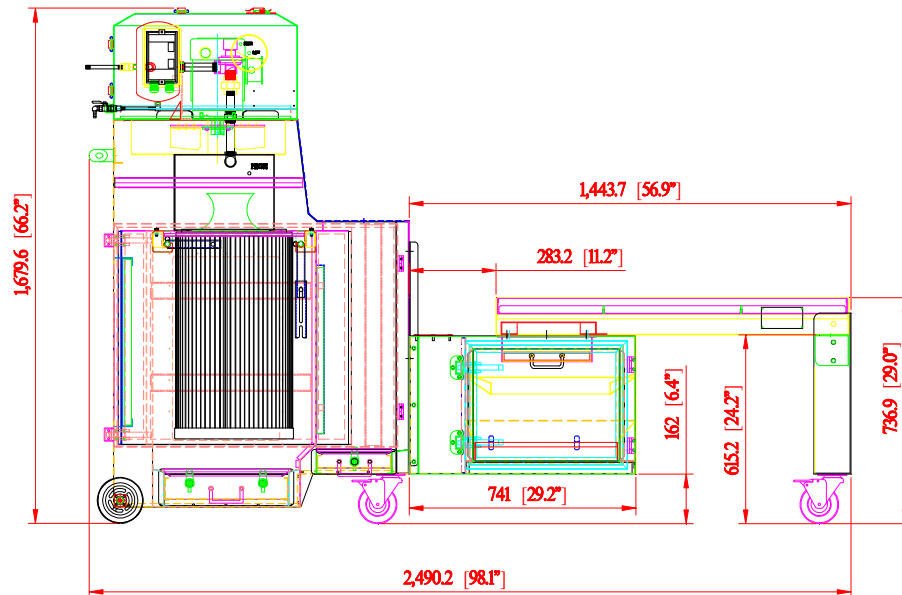
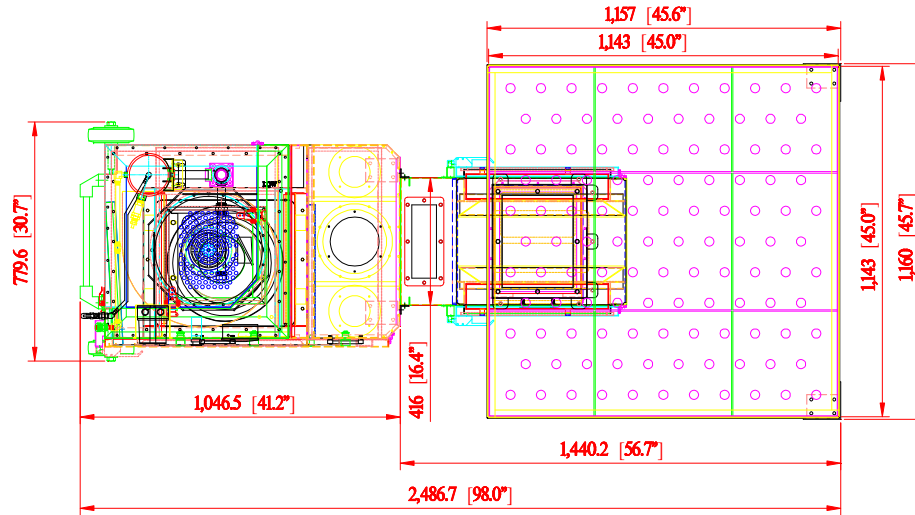

PRELIMINARY

AVANI ENVIRONMENTAL INTL. INC. Sales Department
 95 Cypress Drive (919) 570-2862
 Youngsville, NC 27596 info@avanienvironmental.com

	Date	Name	Part Number:	Title:
Drawn by:	2015-04-13	***	REVISION A	PS-150+RM-150E+DP66-C
Checked by:				
The drawings, AutoCAD, 3-D Models, and specifications are the property of Avani Environmental Intl. Inc. (AE) and may not be reproduced, distributed, modified, or otherwise used, except provided herein, without the express written permission of AE.				

Size **A** Scale 1 = 22

Drawing Number: ***

DO NOT SCALE

IF IN DOUBT ASK

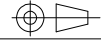

Revisions

Rev	Description	Date	Approved
-----	-------------	------	----------

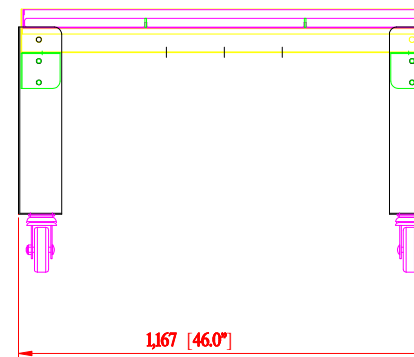
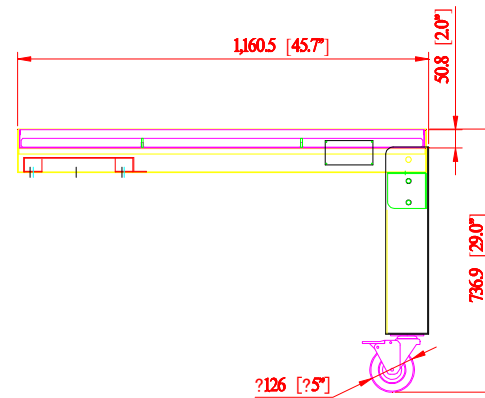
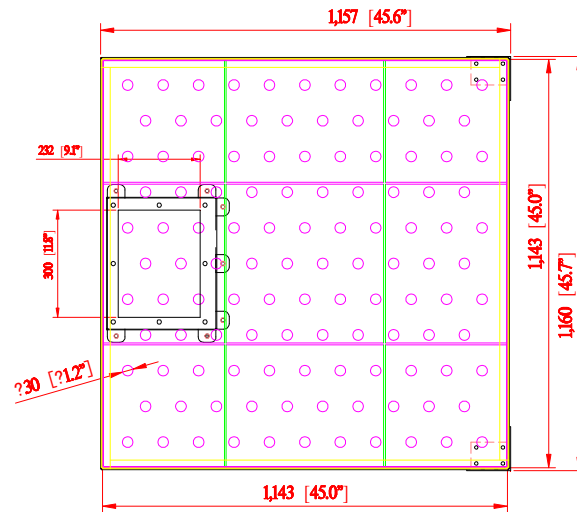

PRELIMINARY

AVANI ENVIRONMENTAL INTL. INC. Sales Department
 95 Cypress Drive (919) 570-2862
 Youngsville, NC 27596 info@avanienvironmental.com

	Date	Name
Drawn by:	2015-04-13	***
Checked by:		

Part Number:
REVISION A

Title:
DP66-C

The drawings, AutoCAD, 3-D Models, and specifications are the property of Avani Environmental Intl. Inc. (AE) and may not be reproduced, distributed, modified, or otherwise used, except provided herein, without the express written permission of AE.

Size
A

Scale
 1 = 15

Drawing Number:
 *** 9

DO NOT SCALE

IF IN DOUBT ASK



Revisions

Rev	Description	Date	Approved

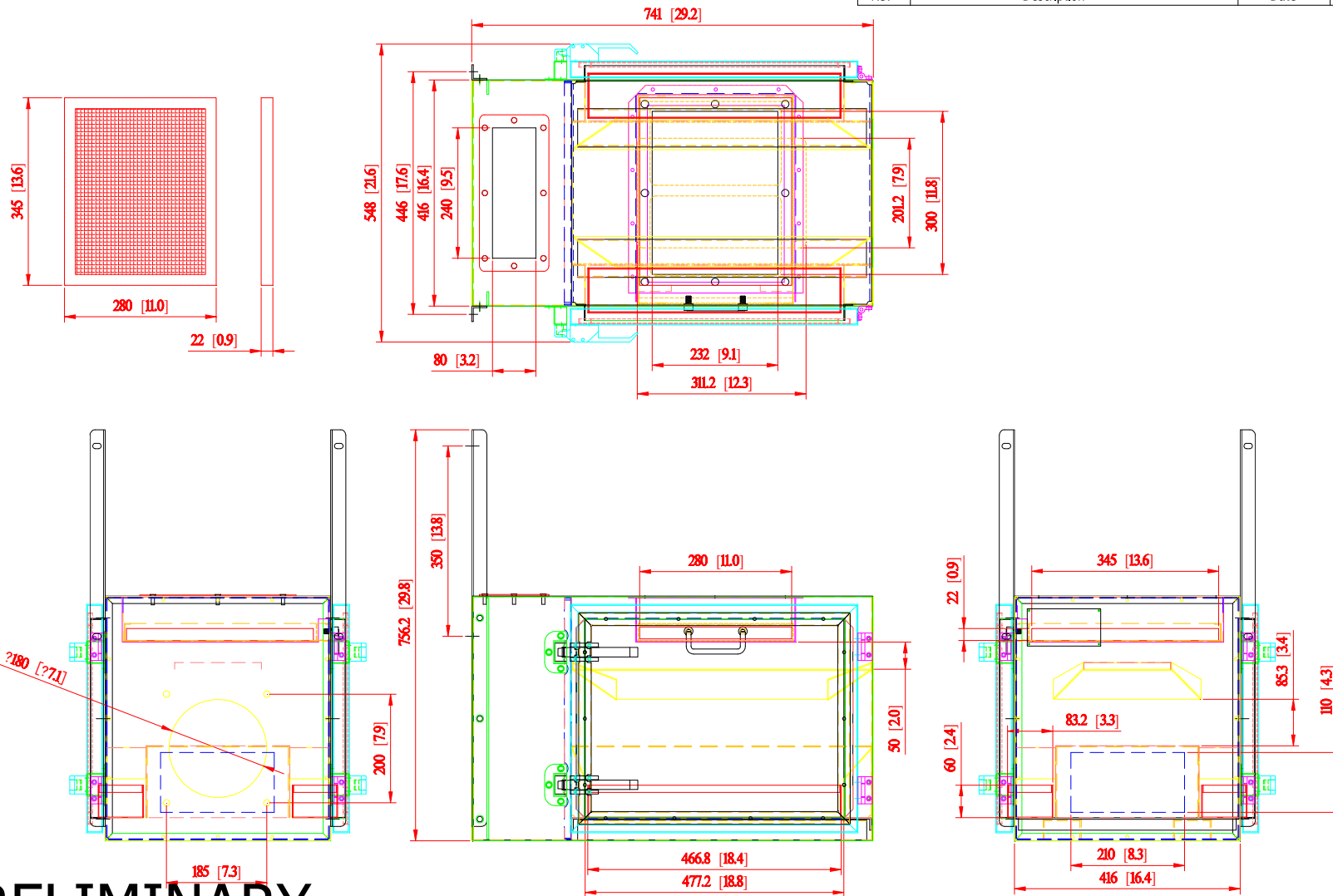

PRELIMINARY

AVANI ENVIRONMENTAL INTL. INC. Sales Department
 95 Cypress Drive (919) 570-2862
 Youngsville, NC 27596 info@avanienvironmental.com

Date	Name	Part Number:	Title:
2015-04-13	***	REVISION A	RM-150E-C
Drawn by:	Checked by:		

The drawings, AutoCAD, 3-D Models, and specifications are the property of Avani Environmental Intl. Inc. (AE) and may not be reproduced, distributed, modified, or otherwise used, except provided herein, without the express written permission of AE.

Size **A**
 Scale 1 = 10

Drawing Number: *** 10

Revisions			
Rev	Description	Date	Approved

BID SPECIFICATION SHEET: WB-1000 (5' X 5') WELDING BOOTH

Each 5' x 5' welding booth comes with fully welded steel side walls, back wall and an integrated fume arm bracket.

The front of the welding booth is open for a welding curtain.

The booth will have a rear-working table with a 2" diameter opening for fixtures.

The booth shall be structurally and engineered to support overhead ducting (from 8" - 48") without having to suspend the ducting from overhead.

This eliminates any stress on the overhead supports and increases lighting and visibility.

WB-1055(5' x 5') BOOTH SPECIFICATIONS

- Dimensions: 60" x 60" x 8.5"
- Support Structure: 2" x 2" Welded Square Stock
- Panel Construction: 12-gauge welded steel wall with 1" welded square stock cross and bracing.
- Welding Curtain Supports: (2) welding curtain brackets
- Welding Curtain Bar
- Fume Arm Bracket: Adjustable and can be mounted on the right or left side.
- Adjustable Feet: Adjustable feet for levelling (2" - 5")
- Powder Coated: Avani Safety Blue Standard (custom colors available)
- Rear Shelf (18" x 59" solid with built in 2" fixture holder)
- Booths can be mounted back-to-back, side-to-side or both options (holes predrilled)
- Three Piece Configuration: (1) Back panel, (2) Side Panels.
- Welded Nuts: Optional locations for J-Hooks

WB-1000 OPTIONS

- Fume Arm
- 110V electrical outlet
- Explosion proof lighting
- J-Hooks
- Welder Shelves
- Air/Gas lines
- Back draft slotted hood
- Fixtures
- Oversized fume arm hood

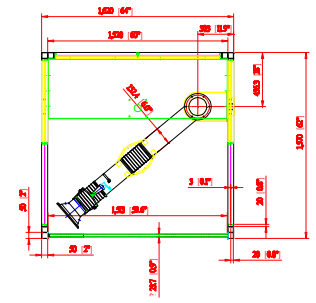

Arm 1620 dia. 6" x 7" hanging arm

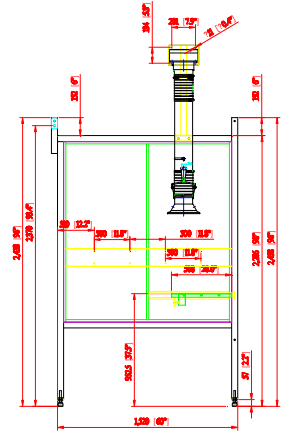
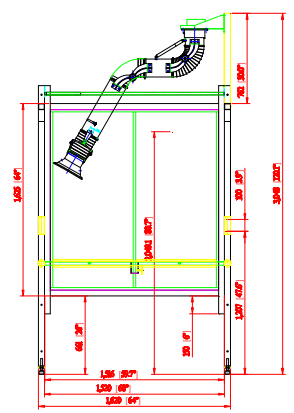

PRELIMINARY

AVANI ENVIRONMENTAL INTL. INC. Sales Department
 95 Cypress Drive
 Youngsville, NC 27596
 (919) 570-2862
 info@avanienvironmental.com

Date	Name	Part Number:	Title:
2015-04-14	***	REVISION A	Booth WB-1055-C
Drawn by:	Checked by:	The drawings, AutoCAD, 3-D Models, and specifications are the property of Avani Environmental Int. Inc. (AE) and may not be reproduced, distributed, modified, or otherwise used, except provided herein, without the express written permission of AE.	

Size	Scale	Drawing Number:
A	1 = 25	WB-5x5S-C

DO NOT SCALE

IF IN DOUBT ASK



Revisions

Rev	Description	Date	Approved
-----	-------------	------	----------

Hanging Arm 6"*7'

Diameter: 6"

Length: 7'

Weight: 37.7 lbs (net)

Arm Construction: Two galvanized steel tubes, three pieces of flex hose at joints, aluminum hood, heavy gauge steel swivel base, and support spring.

Arm Adjustment: Externally supported, adjustments are quickly done at the joints.

Hood: 13" diameter round aluminum hood.

Damper: Internal with external adjustment.

Finish: Powder coated.

Hose: Rated at 160°F

Accessories: Mounting bracket and light kit.

Mounting Bracket:

Warranty: Limited two years from date of purchase.

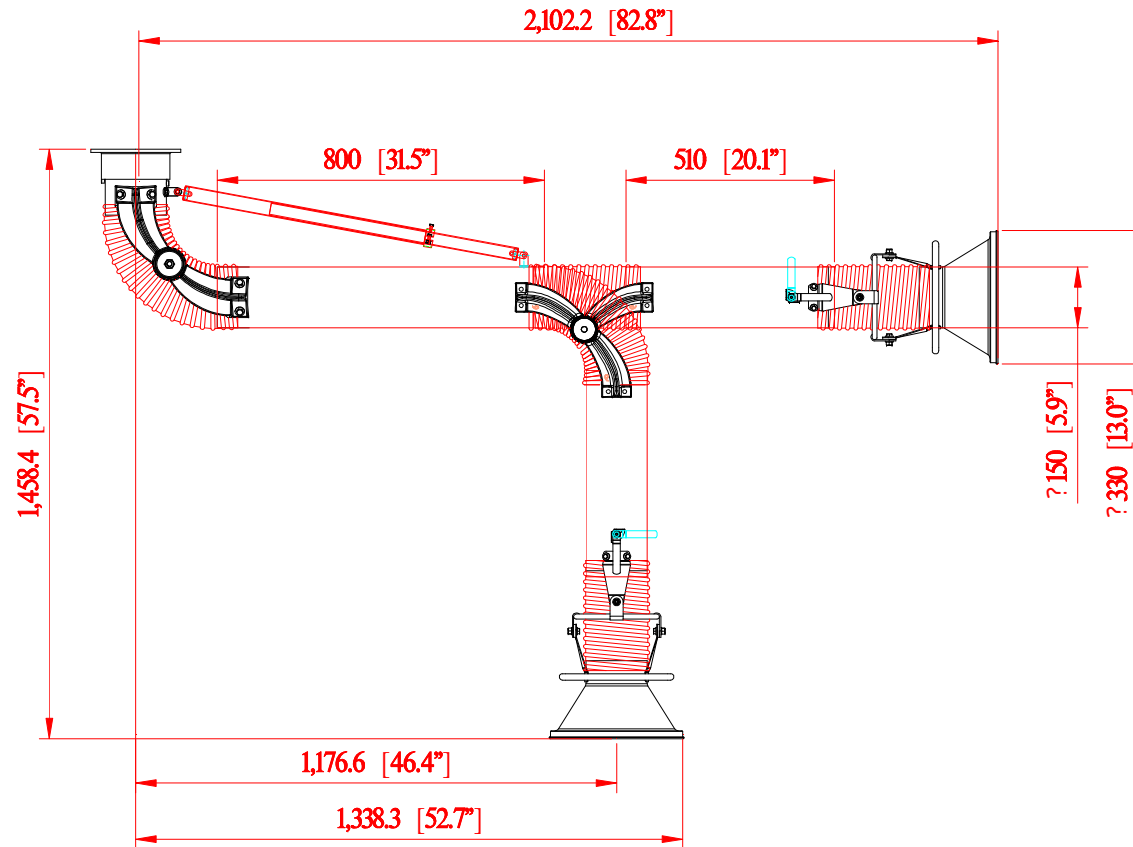

Packing Size:	161 x 38.5 x 69.5 cm 63.4 x 15.2 x 27.4 inch
N.W. / G.W.:	17.1 / 20.6 kgs 37.7 / 45.4 lbs

AVANI ENVIRONMENTAL INTL. INC. Sales Department
95 Cypress Drive (919) 570-2862
Youngsville, NC 27596 info@avanienvironmental.com

	Date	Name	Part Number:	Title:
Drawn by:	2009-12-18	***	**	Arm 1620
Checked by:				

The drawings, AutoCAD, 3-D Models, and specifications are the property of Avani Environmental Intl. Inc. (AE) and may not be reproduced, distributed, modified, or otherwise used, except provided herein, without the express written permission of AE.

Size	Scale	Drawing Number:
A	1 = xx	2009.12.18

DO NOT SCALE

IF IN DOUBT ASK



Revisions			
Rev	Description	Date	Approved

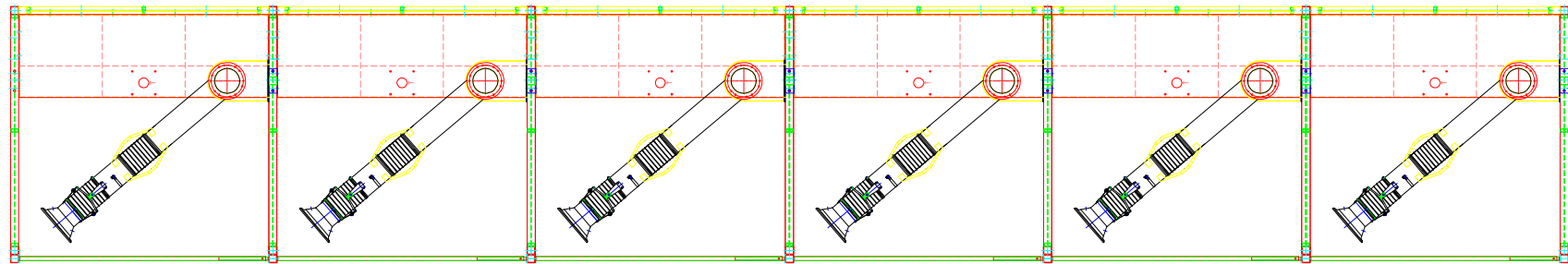

PRELIMINARY

AVANI ENVIRONMENTAL INTL. INC. Sales Department
 95 Cypress Drive
 Youngsville, NC 27596

(919) 570-2862
 info@avanienvironmental.com

	Date	Name	Part Number:
Drawn by:	2015-04-14	***	REVISION A
Checked by:			
The drawings, AutoCAD, 3-D Models, and specifications are the property of Avani Environmental Intl. Inc. (AE) and may not be reproduced, distributed, modified, or otherwise used, except provided herein, without the express written permission of AE.			

Title:	
Welding booths: WB-1055-C layout	
Size	Scale
A	1 = 15
Drawing Number:	
Welding booths: WB-1055-C layout	13









