

DO NOT SCALE

IF IN DOUBT ASK

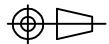

Collector Outlet

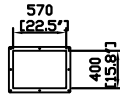

Collector Inlet

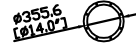

Silencer Outlet

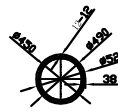

Blower Inlet

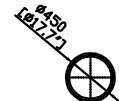

PLAN DETAIL

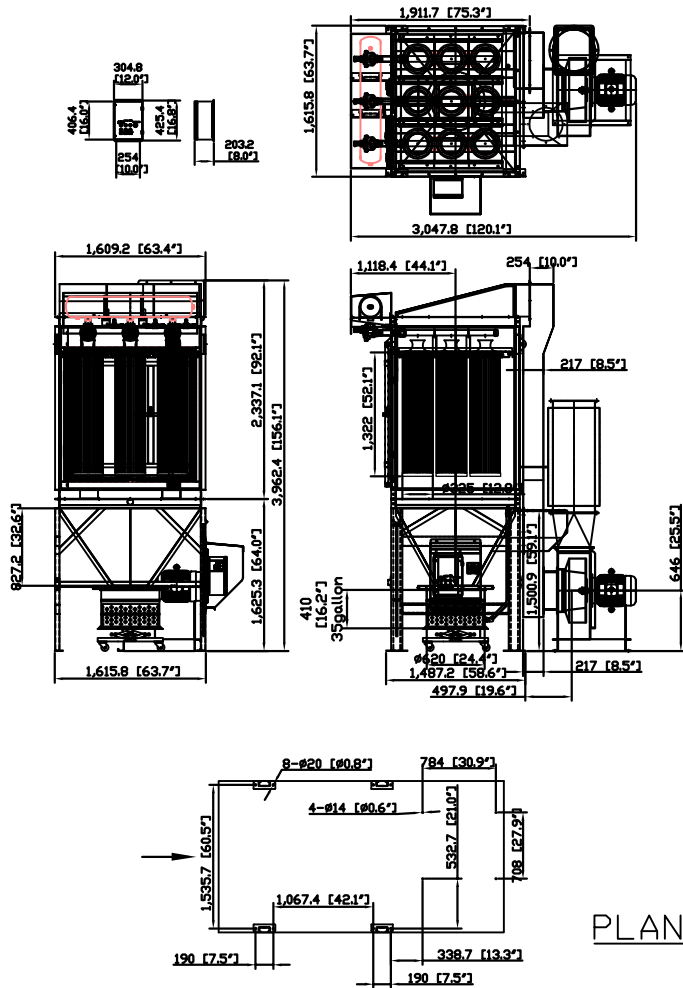

Revisions

Rev	Description	Date	Approved
-----	-------------	------	----------

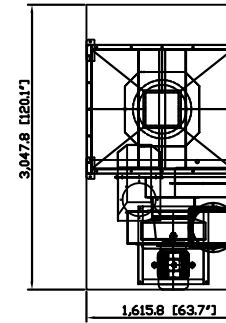

② : silencer

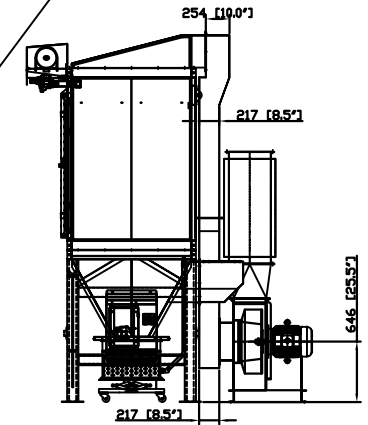
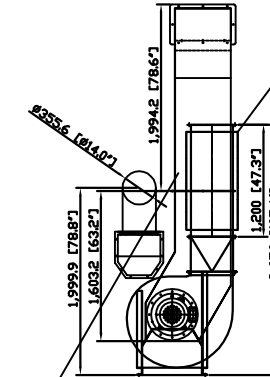
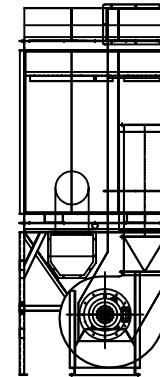

① : pipe ducting from the collector outlet to blower inlet

AVANI ENVIRONMENTAL INTL. INC. Sales Department  
 95 Cypress Drive  
 Youngsville, NC 27596

(919) 570-2862  
 info@avanienvironmental.com

Drawn by:	Date	Name
Checked by:	2011-03-15	***
	2011-02-09	2011-01-10

Part Number:  
**SDC-15G-9**

Title:  
**Large Cartridge Collector**

The drawings, AutoCAD, 3-D Models, and specifications are the property of Avani Environmental Intl. Inc. (AE) and may not be reproduced, distributed, modified, or otherwise used, except provided herein, without the express written permission of AE.

Size  
**A**

Scale  
 1 = 45

Drawing Number:  
 \*\*\*