



**Date:** June 08, 2011

**Project:** Welding Booth

**To:** IOC, Canada

**Attn:**

**Recommended Equipment:**

Welding Booth

---

**Avani Environmental Intl. Inc.**  
95 Cypress Drive  
Youngsville, NC 27596  
[www.avanienvironmental.com](http://www.avanienvironmental.com)

Phone: (919) 570-2862  
Fax: (919) 570-2863  
Email: [info@avanienvironmental.com](mailto:info@avanienvironmental.com)  
[www.weldingbooths.com](http://www.weldingbooths.com)

The drawings, AutoCAD, 3-D Models, and specifications are the property of Avani Environmental Intl. Inc. (AE) and may not be reproduced, distributed, modified, or otherwise used, except provided herein, without the express written permission of AE.

DO NOT SCALE

IF IN DOUBT ASK



Revisions			
Rev	Description	Date	Approved

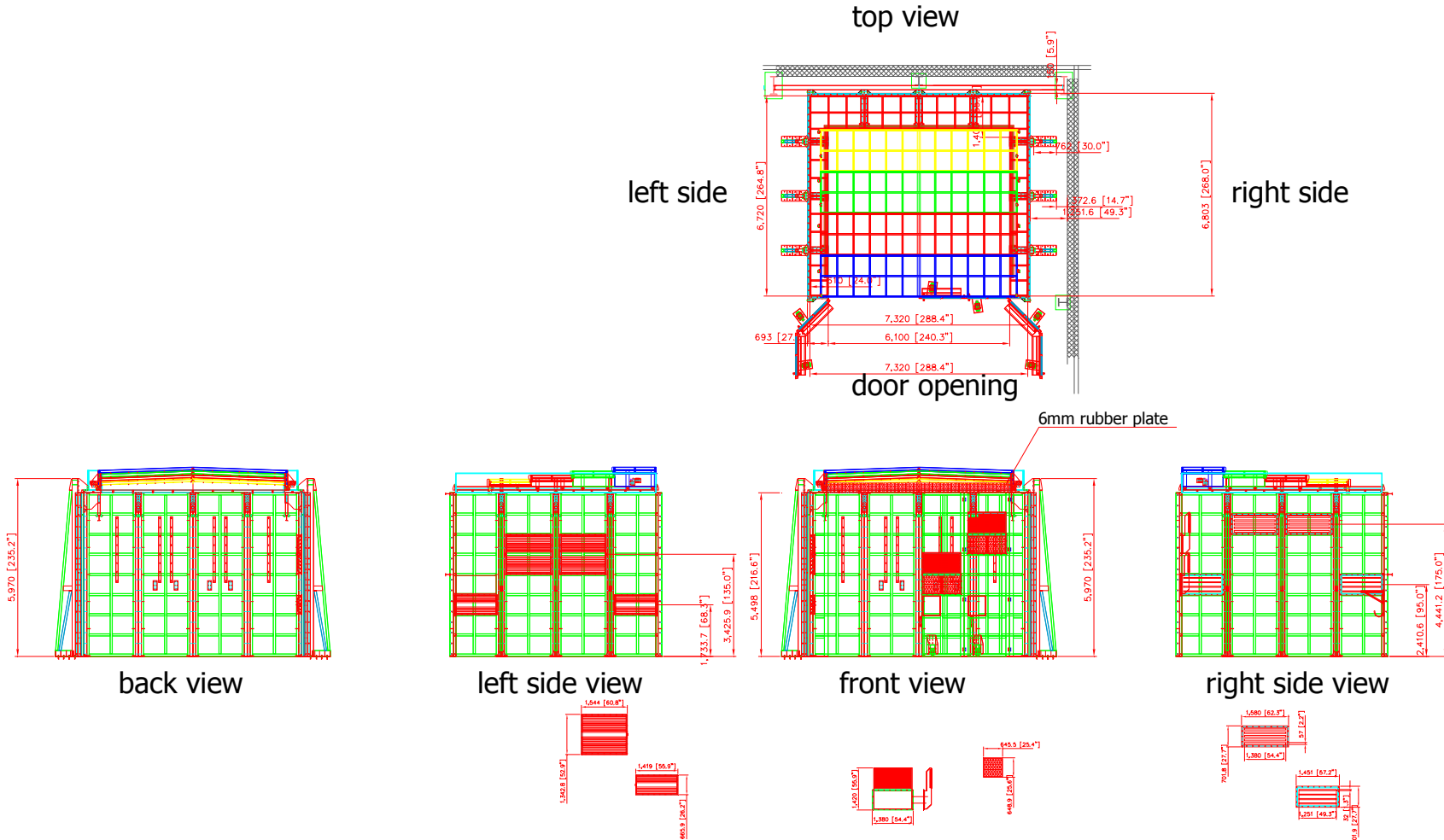

AVANI ENVIRONMENTAL INTL. INC. Sales Department  
 95 Cypress Drive  
 Youngsville, NC 27596  
 (919) 570-2862  
 info@avanienvironmental.com

Date	Name	Part Number:
2011-06-08	***	***
Drawn by:	Checked by:	
The drawings, AutoCAD, 3-D Models, and specifications are the property of Avani Environmental Intl. Inc. (AE) and may not be reproduced, distributed, modified, or otherwise used, except provided herein, without the express written permission of AE.		

Title: <b>IOE Welding Booth</b>		
Size <b>I</b>	Scale 1 = 1	Drawing Number: ***

DO NOT SCALE

IF IN DOUBT ASK

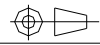

Revisions			
Rev	Description	Date	Approved

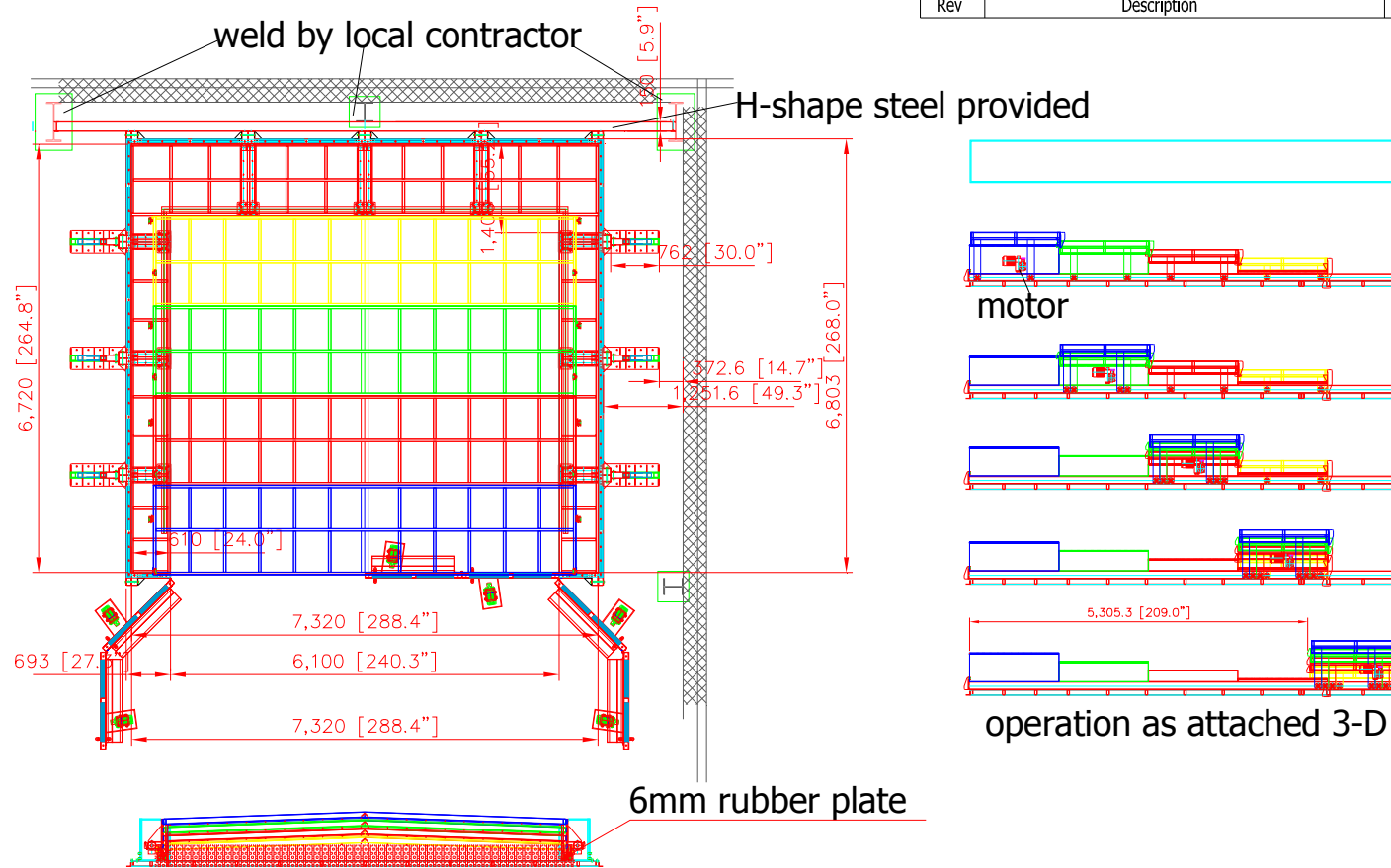

**top cover panel x 3pcs:**

- (1) 293.9" x 47.3" x 3.1"
- (2) 220.2" x 26.8" x 3.1"
- interior gussets: square pipe 2.95" x 2.95" x 2.3mm thickness (13-gauge)
- steel panel cover: 2mm (14-gauge)

**retractable top x 4pcs:**

- (4) 259.7" x 55.2" x 3.2"
- entire open top: 209"
- motor driven

AVANI ENVIRONMENTAL INTL. INC. Sales Department 95 Cypress Drive Youngsville, NC 27596 (919) 570-2862 info@avanienvironmental.com	Date: 2011-06-08 Name: *** Part Number: ***	Title: IOC Welding Booth
	Drawn by: *** Checked by:	Size: I Scale: 1 = 1 Drawing Number: ***
	The drawings, AutoCAD, 3-D Models, and specifications are the property of Avani Environmental Intl. Inc. (AE) and may not be reproduced, distributed, modified, or otherwise used, except provided herein, without the express written permission of AE.	

DO NOT SCALE

IF IN DOUBT ASK

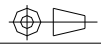

Revisions

Rev	Description	Date	Approved
-----	-------------	------	----------

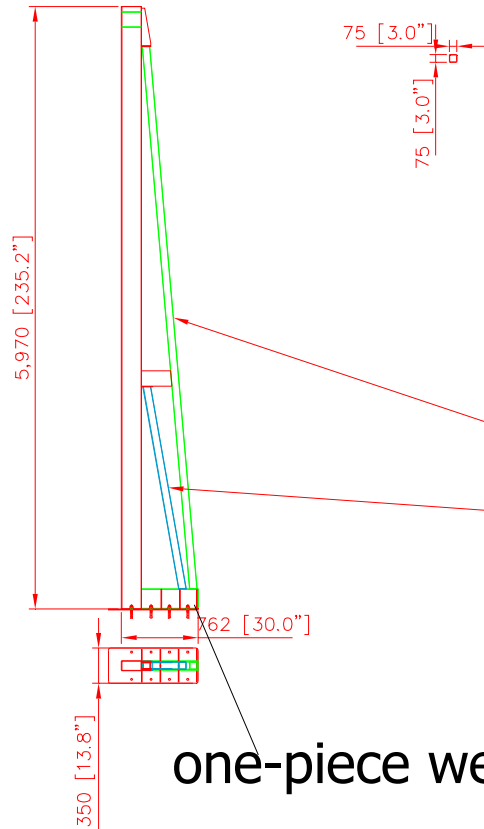

**supports:**

- 235.2" x 30"

**square pipe:**

- (2) 3" x 3" x 0.4"thickness
- (2) 3" x 3" x 0.4"thickness

one-piece weld

AVANI ENVIRONMENTAL INTL. INC. Sales Department  
 95 Cypress Drive (919) 570-2862  
 Youngsville, NC 27596 info@avanienvironmental.com

	Date	Name	Part Number:
Drawn by:	2011-06-08	***	***
Checked by:			

Title: IOC Welding Booth

The drawings, AutoCAD, 3-D Models, and specifications are the property of Avani Environmental Intl. Inc. (AE) and may not be reproduced, distributed, modified, or otherwise used, except provided herein, without the express written permission of AE.

Size I

Scale  
1 = 1

Drawing Number:  
\*\*\*

DO NOT SCALE

IF IN DOUBT ASK



Revisions			
Rev	Description	Date	Approved

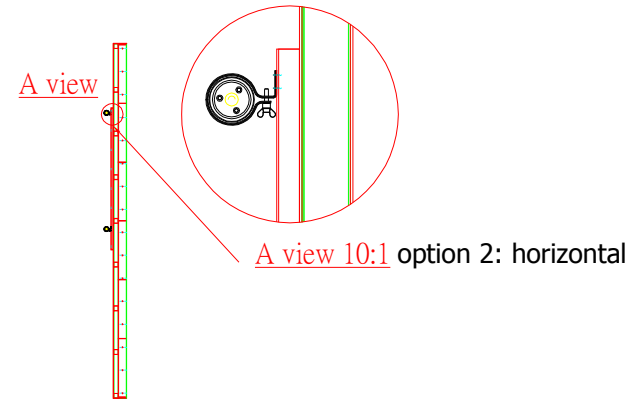
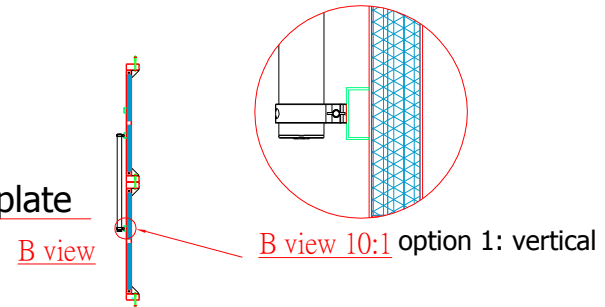
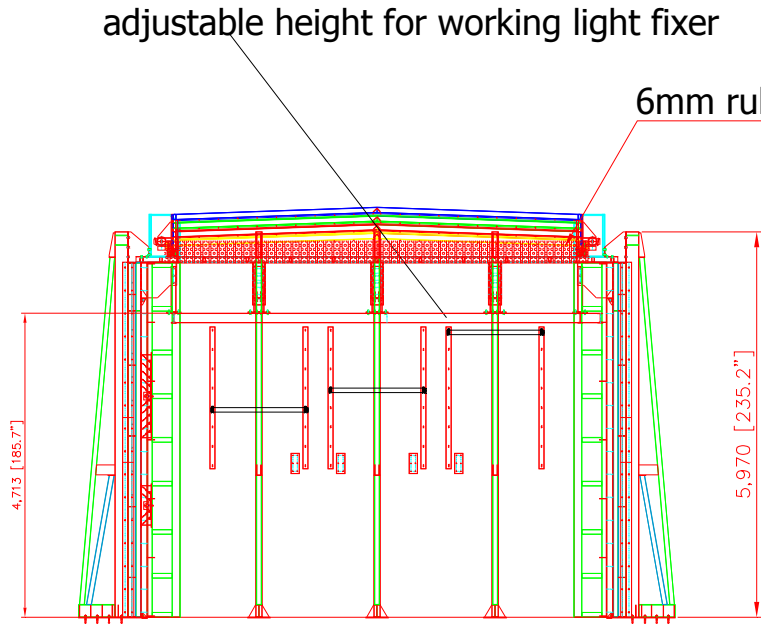

**- H-shape hanging track: 3" x 5.9"**  
**- height off the ground: 185.7"**

AVANI ENVIRONMENTAL INTL. INC. Sales Department  
 95 Cypress Drive (919) 570-2862  
 Youngsville, NC 27596 info@avanienvironmental.com

	Date	Name	Part Number:	Title:
Drawn by:	2011-06-08	***	***	IOC Welding Booth
Checked by:				
The drawings, AutoCAD, 3-D Models, and specifications are the property of Avani Environmental Intl. Inc. (AE) and may not be reproduced, distributed, modified, or otherwise used, except provided herein, without the express written permission of AE.				

Size	Scale	Drawing Number:
I	1 = 1	***

DO NOT SCALE

IF IN DOUBT ASK

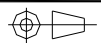

Revisions			
Rev	Description	Date	Approved

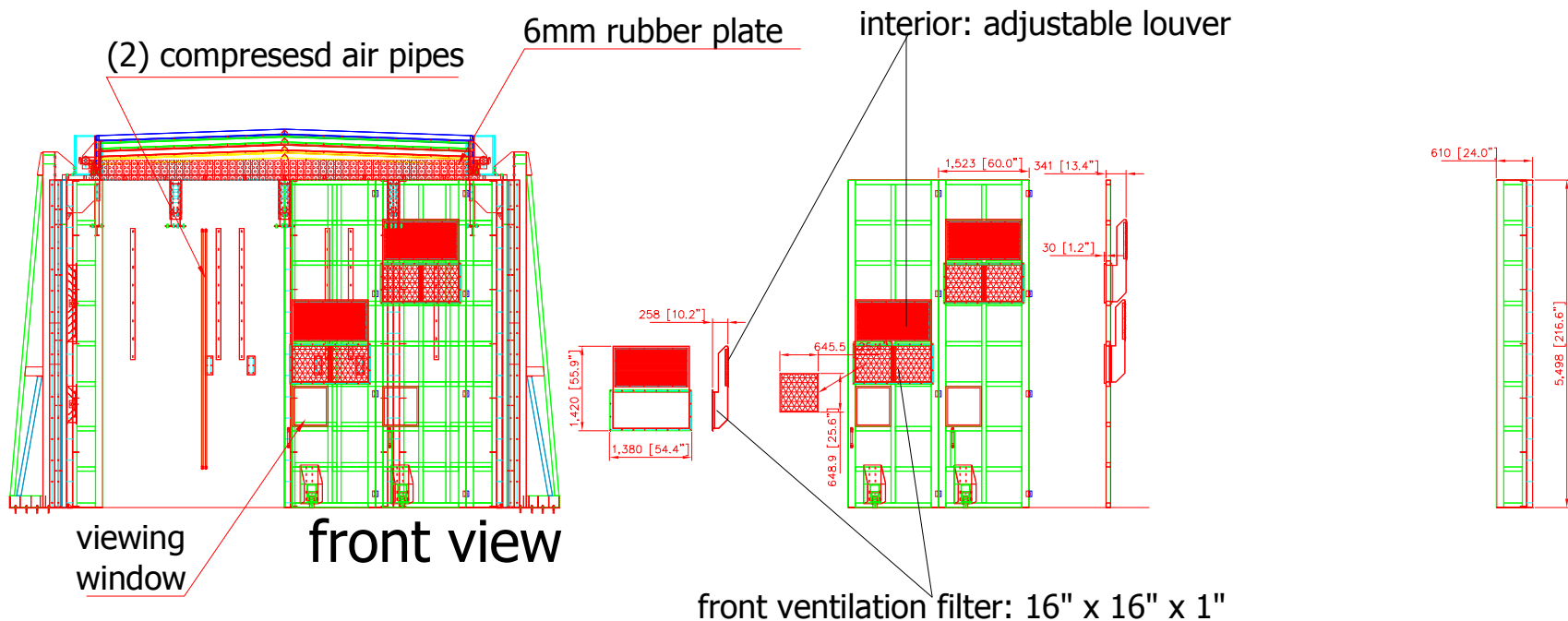

- non-recessed lights: (9) 59.1"L Lights
- front panel: (2) 216.6" x 24" x 3.1"
  - interior gussets: square pipe 2.95" x 2.95" x 2.3mm thickness (13-gauge)
  - steel panel cover: 4mm (8-gauge)
- front door: (4) 216.6" x 60" x 3.1"
  - entire open front: 252.3"
  - interior gussets: square pipe 2.95" x 2.95" x 2.3mm thickness (13-gauge)
  - steel panel cover: 4mm (8-gauge)

AVANI ENVIRONMENTAL INTL. INC. Sales Department 95 Cypress Drive Youngsville, NC 27596 (919) 570-2862 info@avanienvironmental.com	Drawn by:	Date:	Name:	Part Number:	Title:	
	Checked by:	2011-06-08	***	***	IOC Welding Booth	
	The drawings, AutoCAD, 3-D Models, and specifications are the property of Avani Environmental Intl. Inc. (AE) and may not be reproduced, distributed, modified, or otherwise used, except provided herein, without the express written permission of AE.				Size <b>I</b>	Scale 1 = 1

DO NOT SCALE

IF IN DOUBT ASK

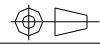

Revisions

Rev	Description	Date	Approved
-----	-------------	------	----------

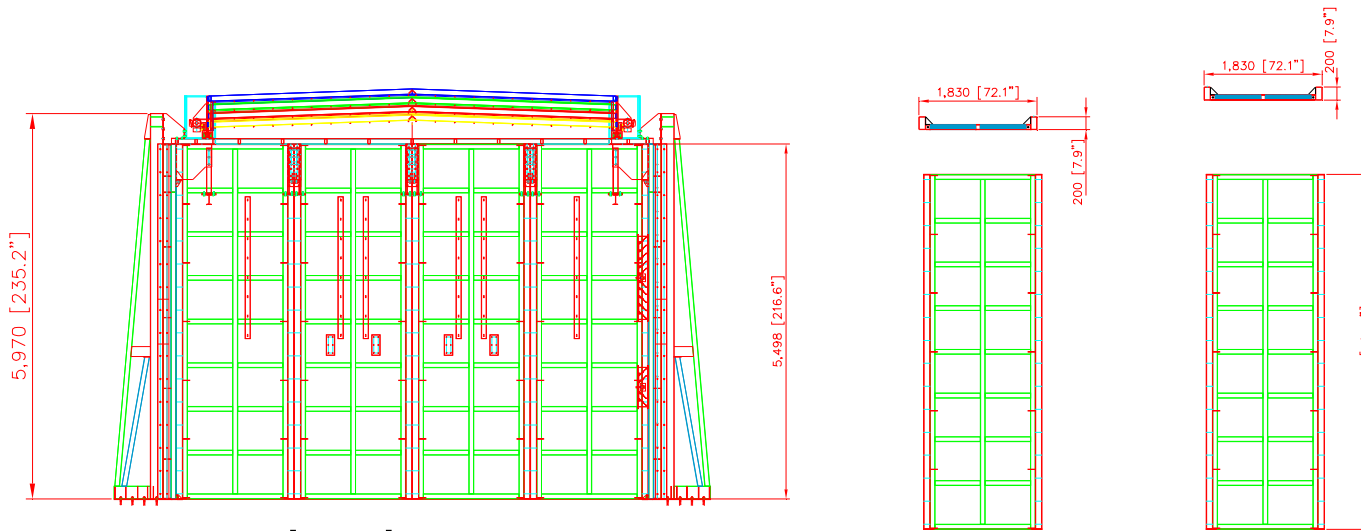

back view

**back panel: (4)**

- (4) 216.6" x 72.1" x 3.1"

- interior gussets: square pipe 2.95" x 2.95" x 2.3mm thickness (13-gauge)
- steel panel cover: 4mm (8-gauge)

AVANI ENVIRONMENTAL INTL. INC. Sales Department  
 95 Cypress Drive (919) 570-2862  
 Youngsville, NC 27596 info@avanienvironmental.com

	Date	Name	Part Number:
Drawn by:	2011-06-08	***	***
Checked by:			

Title: **IOC Welding Booth**

The drawings, AutoCAD, 3-D Models, and specifications are the property of Avani Environmental Intl. Inc. (AE) and may not be reproduced, distributed, modified, or otherwise used, except provided herein, without the express written permission of AE.

Size **I**

Scale 1 = 1

Drawing Number: \*\*\*

DO NOT SCALE

IF IN DOUBT ASK

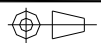

Revisions			
Rev	Description	Date	Approved

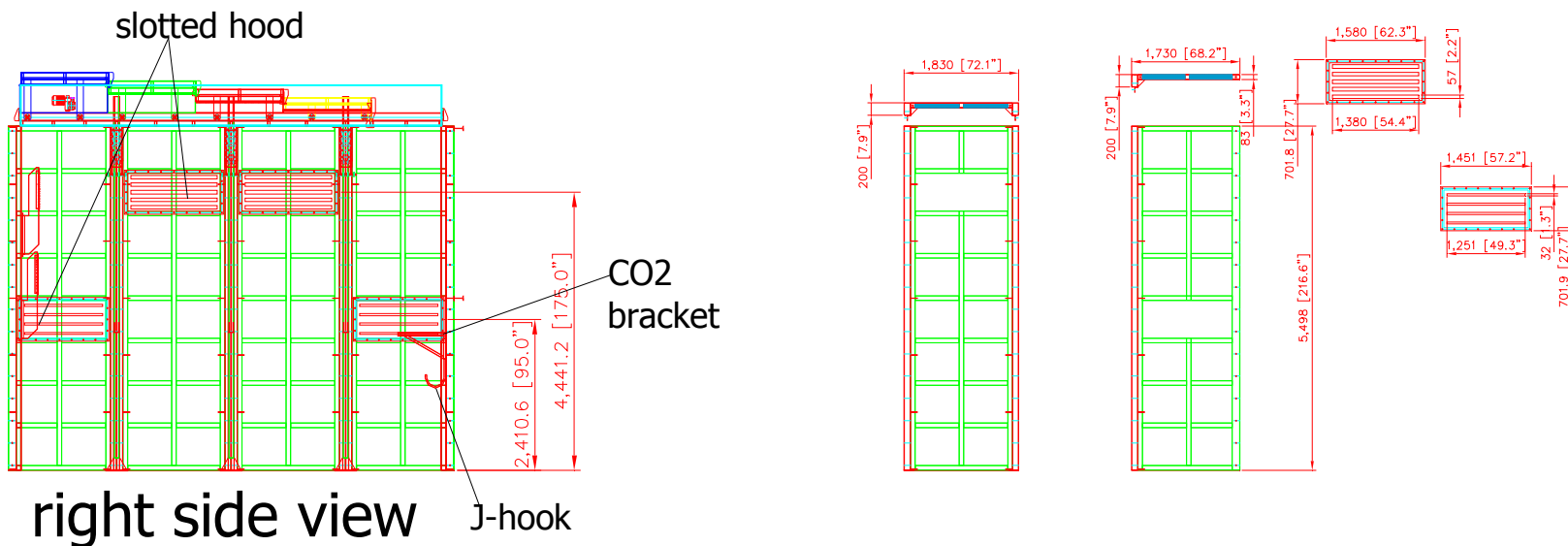

**side panel x 4pcs:**

- (2) 72.1" x 216.6" x 3.1" (inlet opening: 62.3" x 27.7")
  - interior gussets: square pipe 2.95" x 2.95" x 2.3mm thickness (13-gauge)
  - steel panel cover: 4mm (8-gauge)
  
- (2) 68.2" x 216.6" x 3.1" (inlet opening: 57.2" x 27.7")
  - interior gussets: square pipe 2.95" x 2.95" x 2.3mm thickness (13-gauge)
  - steel panel cover: 4mm (8-gauge)

AVANI ENVIRONMENTAL INTL. INC. Sales Department  
 95 Cypress Drive  
 Youngsville, NC 27596  
 (919) 570-2862  
 info@avanienvironmental.com

Drawn by:	Date	Name	Part Number:	Title:
Checked by:	2011-06-08	***	***	IOC Welding Booth
The drawings, AutoCAD, 3-D Models, and specifications are the property of Avani Environmental Intl. Inc. (AE) and may not be reproduced, distributed, modified, or otherwise used, except provided herein, without the express written permission of AE.				Drawing Number:
Size I				***

Scale	Drawing Number:
1 = 1	***



DO NOT SCALE

IF IN DOUBT ASK



Revisions

Rev	Description	Date	Approved
-----	-------------	------	----------

adjustable louver

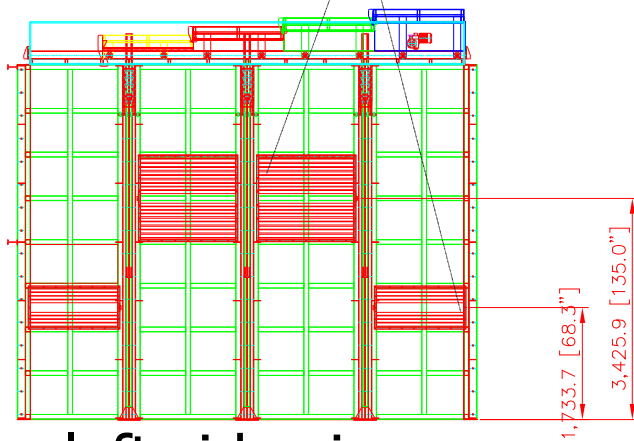

left side view

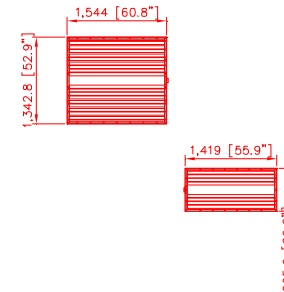
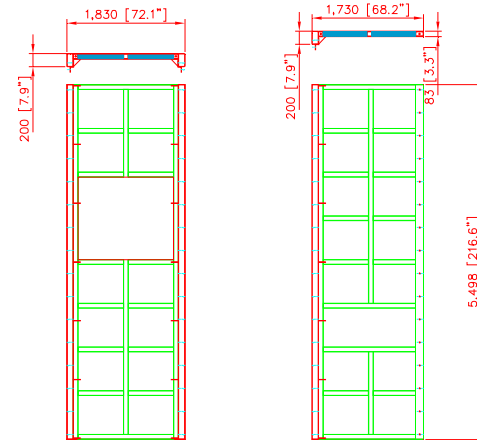

side panel x 4pcs:

- (2) 72.1" x 216.6" x 3.1" (inlet opening: 60.8" x 52.9")
  - interior gussets: square pipe 2.95" x 2.95" x 2.3mm thickness (13-gauge)
  - steel panel cover: 4mm (8-gauge)
- (2) 68.2" x 216.6" x 3.1" (inlet opening: 55.9" x 26.2")
  - interior gussets: square pipe 2.95" x 2.95" x 2.3mm thickness (13-gauge)
  - steel panel cover: 4mm (8-gauge)

AVANI ENVIRONMENTAL INTL. INC. Sales Department  
 95 Cypress Drive (919) 570-2862  
 Youngsville, NC 27596 info@avanienvironmental.com

Drawn by:	Date	Name	Part Number:	Title:
Checked by:	2011-06-08	***	***	IOC Welding Booth

The drawings, AutoCAD, 3-D Models, and specifications are the property of Avani Environmental Intl. Inc. (AE) and may not be reproduced, distributed, modified, or otherwise used, except provided herein, without the express written permission of AE.

Size	Scale	Drawing Number:
I	1 = 1	***

DO NOT SCALE

IF IN DOUBT ASK

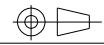

Revisions

Rev	Description	Date	Approved
-----	-------------	------	----------

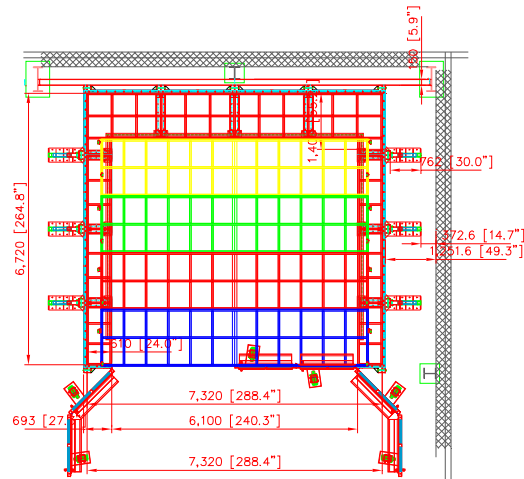

上視圖

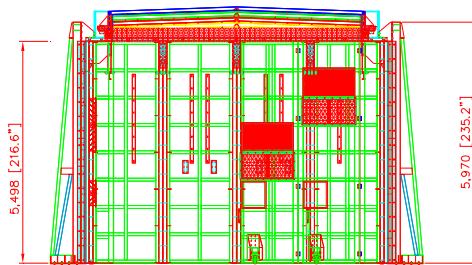

front view

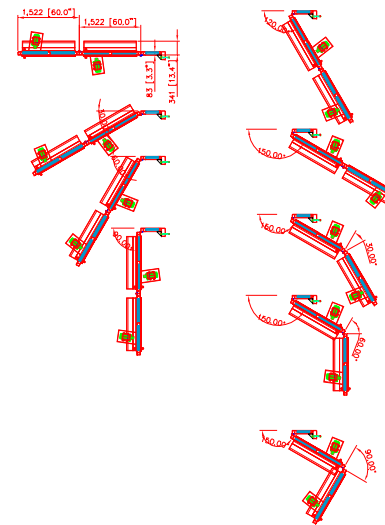

door operation

AVANI ENVIRONMENTAL INTL. INC. Sales Department  
 95 Cypress Drive  
 Youngsville, NC 27596  
 (919) 570-2862  
 info@avanienvironmental.com

Date	Name	Part Number:
2011-06-08	***	***
Drawn by:	Checked by:	

The drawings, AutoCAD, 3-D Models, and specifications are the property of Avani Environmental Intl. Inc. (AE) and may not be reproduced, distributed, modified, or otherwise used, except provided herein, without the express written permission of AE.

Title: **IOC Welding Booth**

Size	Scale	Drawing Number:
<b>I</b>	1 = 1	***

retractable top: motor driven

