



Date: June 06, 2011

Project: Welding Booth

To: IOC, Canada

Attn:

Recommended Equipment:

Welding Booth

Avani Environmental Intl. Inc.
95 Cypress Drive
Youngsville, NC 27596
www.avanienvironmental.com

Phone: (919) 570-2862
Fax: (919) 570-2863
Email: info@avanienvironmental.com
www.weldingbooths.com

The drawings, AutoCAD, 3-D Models, and specifications are the property of Avani Environmental Intl. Inc. (AE) and may not be reproduced, distributed, modified, or otherwise used, except provided herein, without the express written permission of AE.

DO NOT SCALE

IF IN DOUBT ASK



Revisions			
Rev	Description	Date	Approved

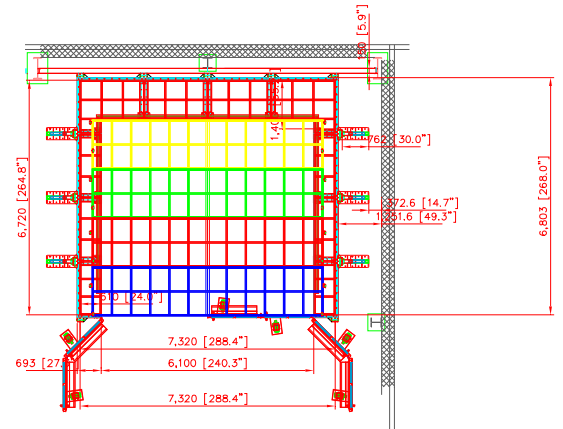

6mm rubber plate

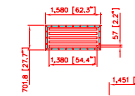
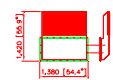
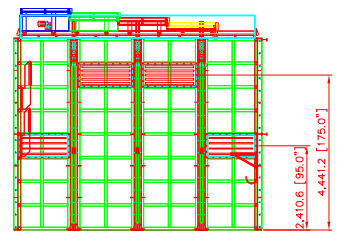
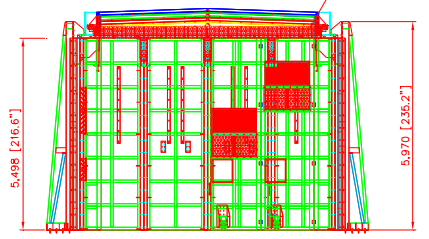
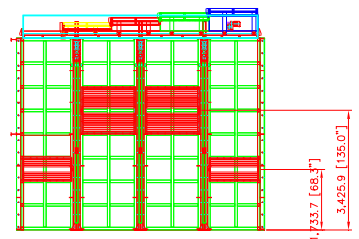
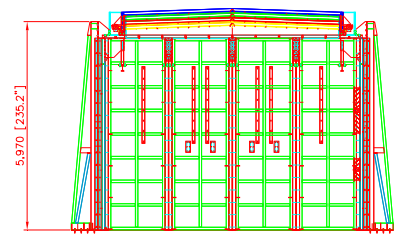

AVANI ENVIRONMENTAL INTL. INC. Sales Department
 95 Cypress Drive
 Youngsville, NC 27596
 (919) 570-2862
 info@avanienvironmental.com

Date	Name	Part Number:
2011-06-06	***	***
Drawn by:	Checked by:	

The drawings, AutoCAD, 3-D Models, and specifications are the property of Avani Environmental Intl. Inc. (AE) and may not be reproduced, distributed, modified, or otherwise used, except provided herein, without the express written permission of AE.

Title: IOC Welding Booth		
Size H	Scale 1 = 1	Drawing Number: ***

DO NOT SCALE

IF IN DOUBT ASK

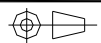

Revisions			
Rev	Description	Date	Approved

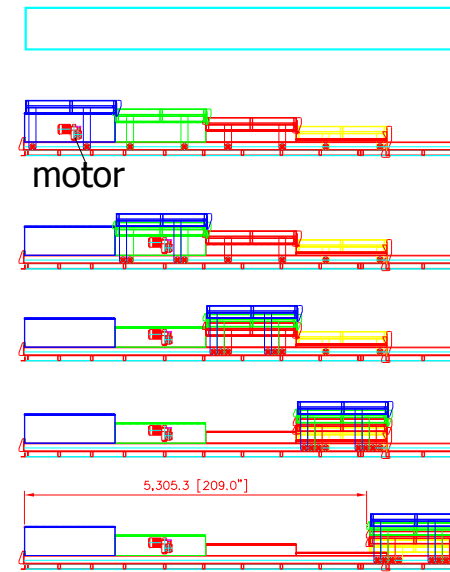
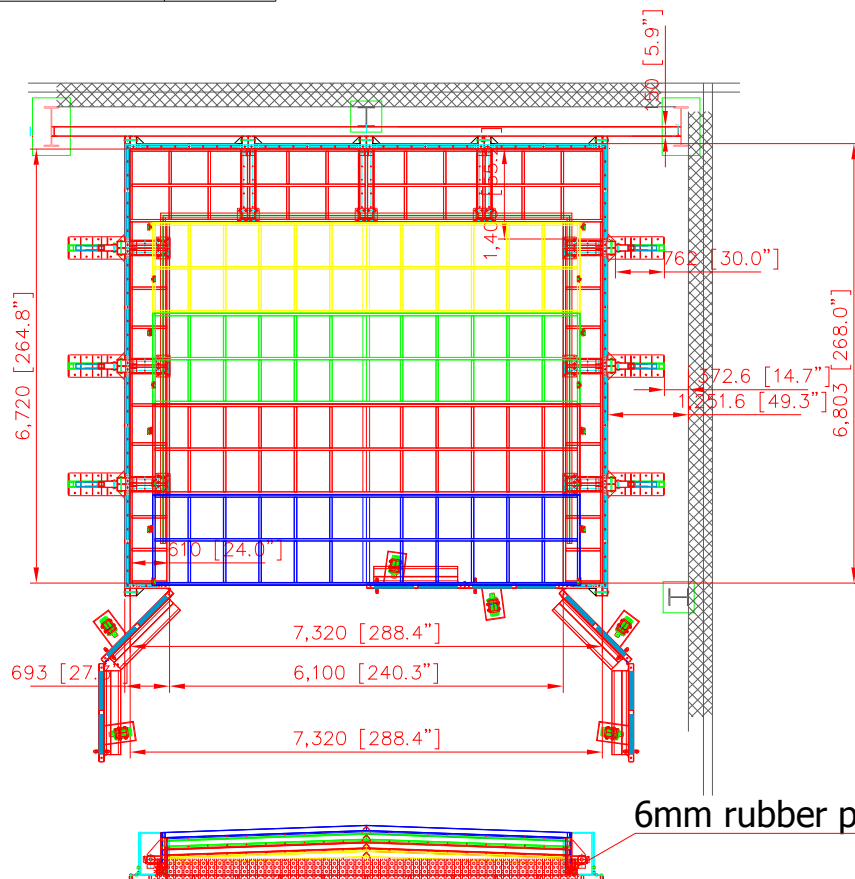

top cover panel x 3pcs:

- (1) 293.9" x 47.3" x 3.1"
- (2) 220.2" x 26.8" x 3.1"
- interior gussets: square pipe 2.95" x 2.95" x 2.3mm thickness (13-gauge)
- steel panel cover: 2mm (14-gauge)

retractable top x 4pcs:

- (4) 259.7" x 55.2" x 3.2"
- entire open top: 209"
- motor driven

AVANI ENVIRONMENTAL INTL. INC. Sales Department
 95 Cypress Drive (919) 570-2862
 Youngsville, NC 27596 info@avanienvironmental.com

Date	Name	Part Number:
2011-06-06	***	***
Drawn by:	Checked by:	

The drawings, AutoCAD, 3-D Models, and specifications are the property of Avani Environmental Intl. Inc. (AE) and may not be reproduced, distributed, modified, or otherwise used, except provided herein, without the express written permission of AE.

Title: IOC Welding Booth		
Size H	Scale 1 = 1	Drawing Number: ***

DO NOT SCALE

IF IN DOUBT ASK



Revisions

Rev	Description	Date	Approved
-----	-------------	------	----------

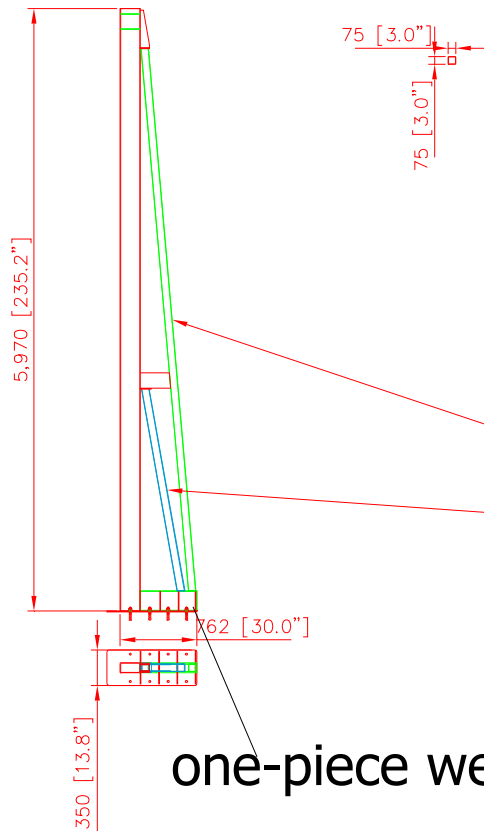

supports:

- 235.2" x 30"

square pipe:

- (2) 3" x 3" x 0.4"thickness
- (2) 3" x 3" x 0.4"thickness

one-piece weld

AVANI ENVIRONMENTAL INTL. INC. Sales Department
 95 Cypress Drive (919) 570-2862
 Youngsville, NC 27596 info@avanienvironmental.com

Date	Name	Part Number:
2011-06-06	***	***
Checked by:		

Title: IOC Welding Booth

The drawings, AutoCAD, 3-D Models, and specifications are the property of Avani Environmental Intl. Inc. (AE) and may not be reproduced, distributed, modified, or otherwise used, except provided herein, without the express written permission of AE.

Size	Scale	Drawing Number:
H	1 = 1	***

DO NOT SCALE

IF IN DOUBT ASK



Revisions

Rev	Description	Date	Approved
-----	-------------	------	----------

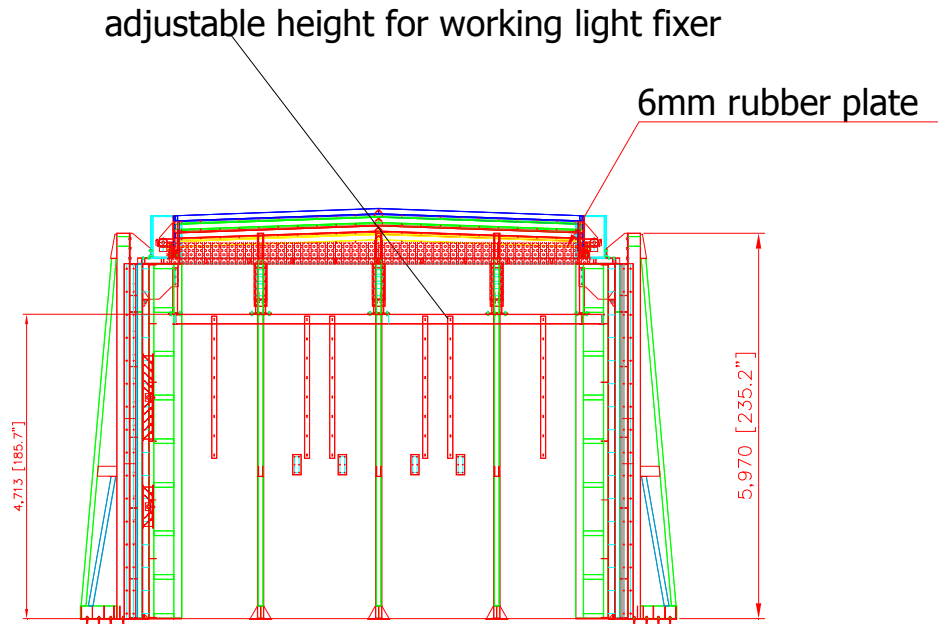

- H-shape hanging track: 3" x 5.9"
- height off the ground: 185.7"

AVANI ENVIRONMENTAL INTL. INC. Sales Department
 95 Cypress Drive
 Youngsville, NC 27596
 (919) 570-2862
 info@avanienvironmental.com

Date	Name	Part Number:
2011-06-06	***	***
Checked by:		

Title: **IOC Welding Booth**

The drawings, AutoCAD, 3-D Models, and specifications are the property of Avani Environmental Intl. Inc. (AE) and may not be reproduced, distributed, modified, or otherwise used, except provided herein, without the express written permission of AE.

Size H	Scale 1 = 1	Drawing Number: ***
------------------	----------------	------------------------

DO NOT SCALE

IF IN DOUBT ASK

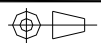

Revisions			
Rev	Description	Date	Approved

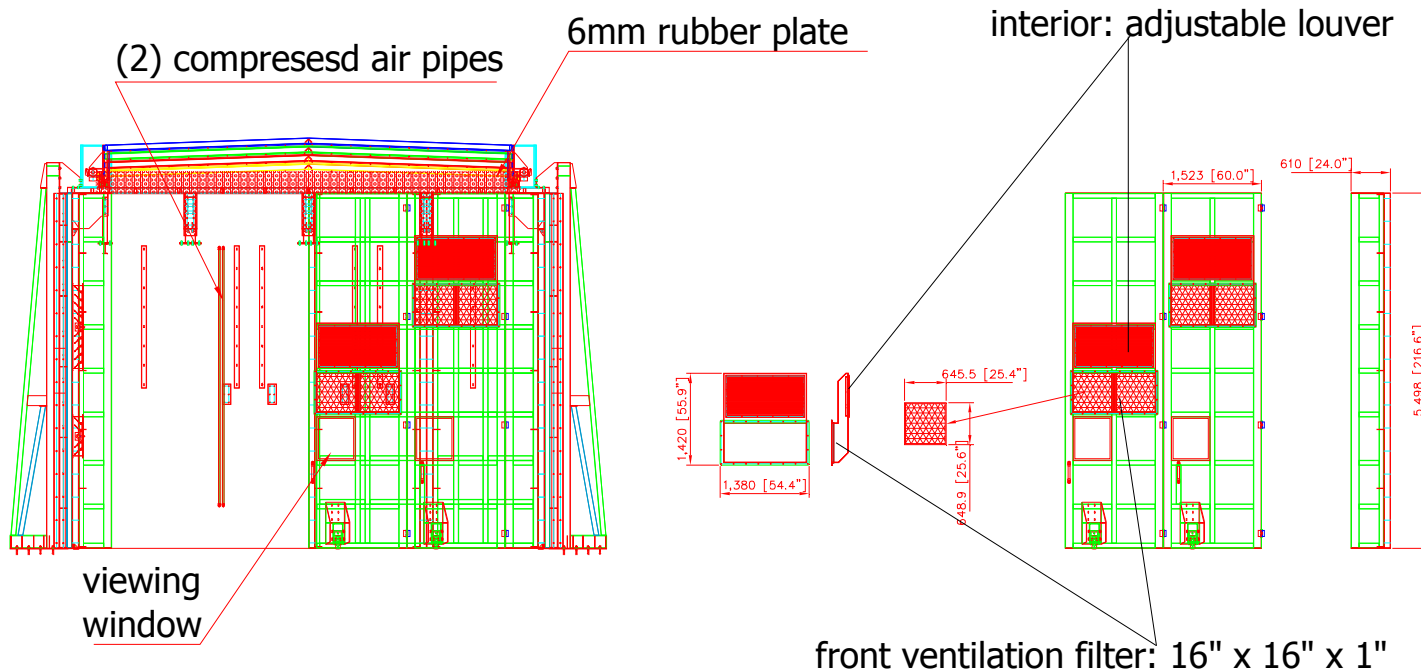

- non-recessed lights: (9) 59.1"L Lights
- front panel: (2) 216.6" x 24" x 3.1"
 - interior gussets: square pipe 2.95" x 2.95" x 2.3mm thickness (13-gauge)
 - steel panel cover: 4mm (8-gauge)
- front door: (4) 216.6" x 60" x 3.1"
 - entire open front: 252.3"
 - interior gussets: square pipe 2.95" x 2.95" x 2.3mm thickness (13-gauge)
 - steel panel cover: 4mm (8-gauge)

AVANI ENVIRONMENTAL INTL. INC. Sales Department
 95 Cypress Drive
 Youngsville, NC 27596
 (919) 570-2862
 info@avanienvironmental.com

Drawn by:	Date	Name	Part Number:	Title:
Checked by:	2011-06-06	***	***	IOC Welding Booth
The drawings, AutoCAD, 3-D Models, and specifications are the property of Avani Environmental Intl. Inc. (AE) and may not be reproduced, distributed, modified, or otherwise used, except provided herein, without the express written permission of AE.				Drawing Number:
Size H				***

Scale
1 = 1

Drawing Number:

DO NOT SCALE

IF IN DOUBT ASK



Revisions

Rev	Description	Date	Approved
-----	-------------	------	----------

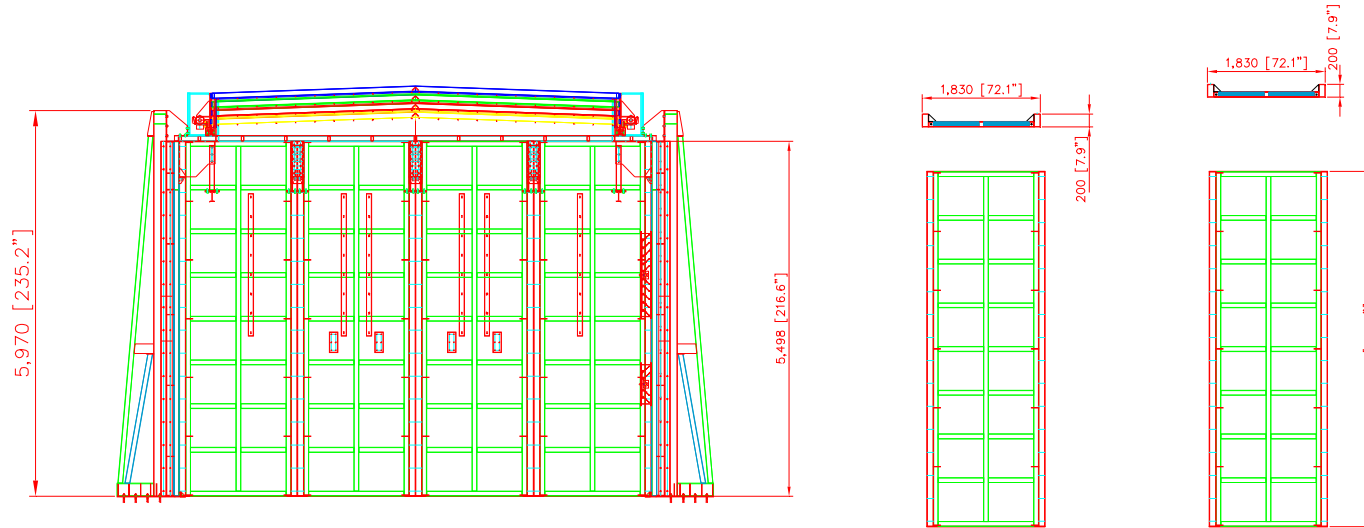

back panel: (4)

- (4) 216.6" x 72.1" x 3.1"

- interior gussets: square pipe 2.95" x 2.95" x 2.3mm thickness (13-gauge)

- steel panel cover: 4mm (8-gauge)

AVANI ENVIRONMENTAL INTL. INC. Sales Department
 95 Cypress Drive
 Youngsville, NC 27596

(919) 570-2862
 info@avanienvironmental.com

	Date	Name	Part Number:
Drawn by:	2011-06-06	***	***
Checked by:			

The drawings, AutoCAD, 3-D Models, and specifications are the property of Avani Environmental Intl. Inc. (AE) and may not be reproduced, distributed, modified, or otherwise used, except provided herein, without the express written permission of AE.

Title: **IOC Welding Booth**

Size H	Scale 1 = 1	Drawing Number: ***
------------------	----------------	------------------------

DO NOT SCALE

IF IN DOUBT ASK

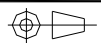

Revisions			
Rev	Description	Date	Approved

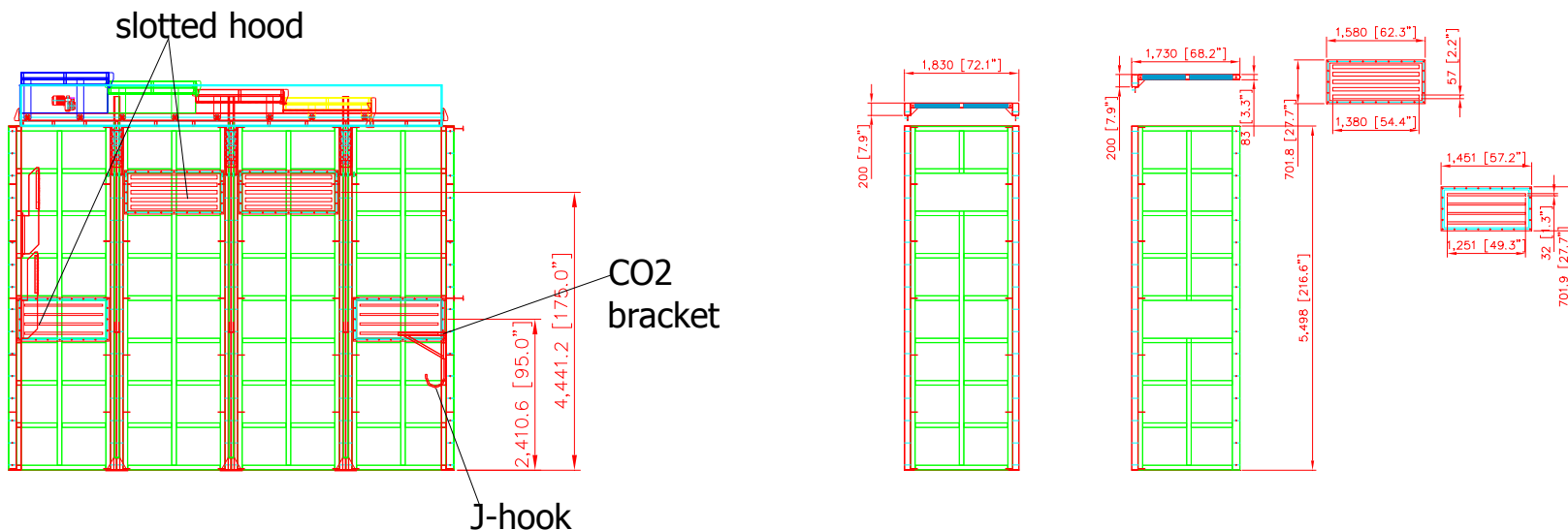

side panel x 4pcs:

- (2) 72.1" x 216.6" x 3.1" (inlet opening: 62.3" x 27.7")
 - interior gussets: square pipe 2.95" x 2.95" x 2.3mm thickness (13-gauge)
 - steel panel cover: 4mm (8-gauge)

- (2) 68.2" x 216.6" x 3.1" (inlet opening: 57.2" x 27.7")
 - interior gussets: square pipe 2.95" x 2.95" x 2.3mm thickness (13-gauge)
 - steel panel cover: 4mm (8-gauge)

AVANI ENVIRONMENTAL INTL. INC. Sales Department
 95 Cypress Drive
 Youngsville, NC 27596
 (919) 570-2862
 info@avanienvironmental.com

Drawn by:	Date	Name	Part Number:
Checked by:	2011-06-06	***	***
The drawings, AutoCAD, 3-D Models, and specifications are the property of Avani Environmental Intl. Inc. (AE) and may not be reproduced, distributed, modified, or otherwise used, except provided herein, without the express written permission of AE.			

Title: IOC Welding Booth		
Size H	Scale 1 = 1	Drawing Number: ***

DO NOT SCALE

IF IN DOUBT ASK



Revisions

Rev	Description	Date	Approved
-----	-------------	------	----------

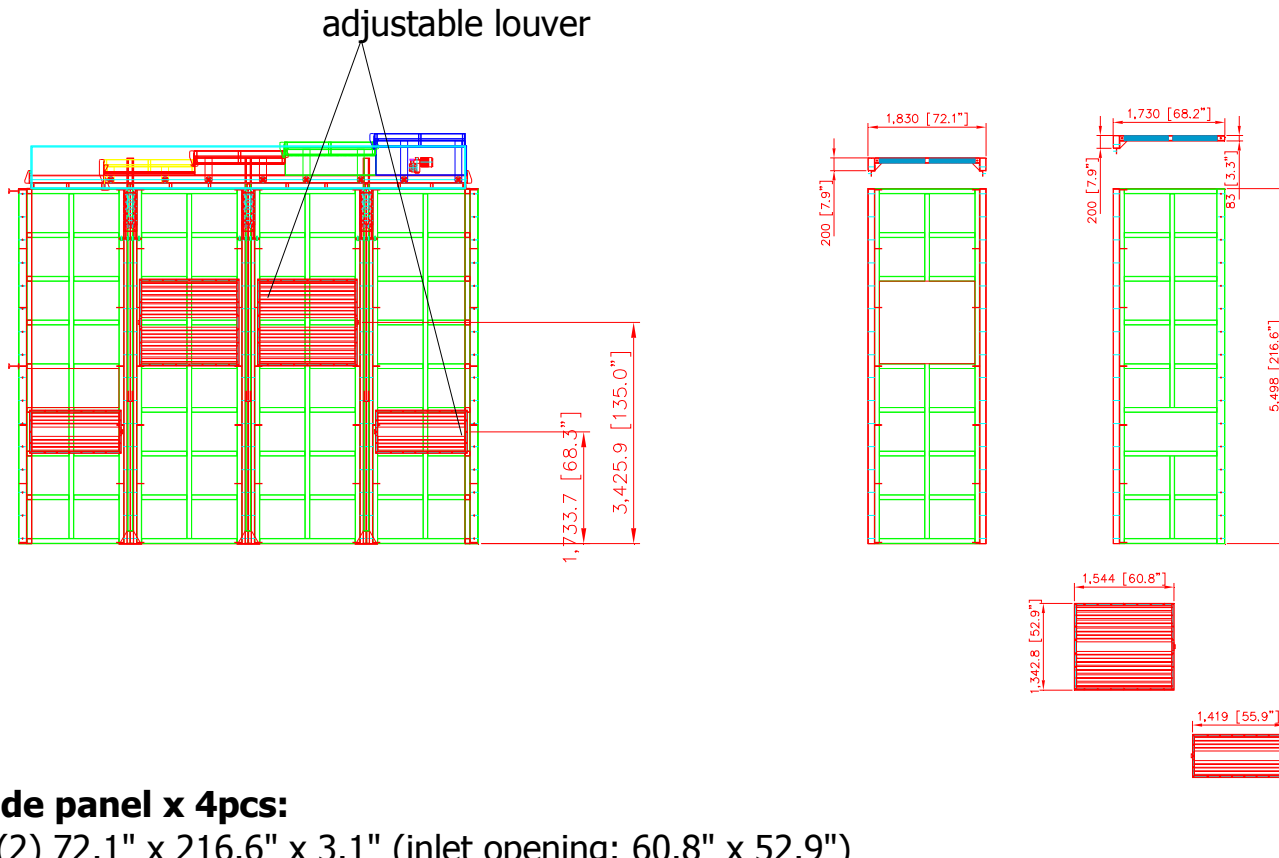

side panel x 4pcs:

- (2) 72.1" x 216.6" x 3.1" (inlet opening: 60.8" x 52.9")
 - interior gussets: square pipe 2.95" x 2.95" x 2.3mm thickness (13-gauge)
 - steel panel cover: 4mm (8-gauge)
- (2) 68.2" x 216.6" x 3.1" (inlet opening: 55.9" x 26.2")
 - interior gussets: square pipe 2.95" x 2.95" x 2.3mm thickness (13-gauge)
 - steel panel cover: 4mm (8-gauge)

AVANI ENVIRONMENTAL INTL. INC. Sales Department
 95 Cypress Drive (919) 570-2862
 Youngsville, NC 27596 info@avanienvironmental.com

Drawn by:	Date	Name	Part Number:	Title:
Checked by:	2011-06-06	***	***	IOC Welding Booth

The drawings, AutoCAD, 3-D Models, and specifications are the property of Avani Environmental Intl. Inc. (AE) and may not be reproduced, distributed, modified, or otherwise used, except provided herein, without the express written permission of AE.

Size	Scale	Drawing Number:
H	1 = 1	***