

BAY-2

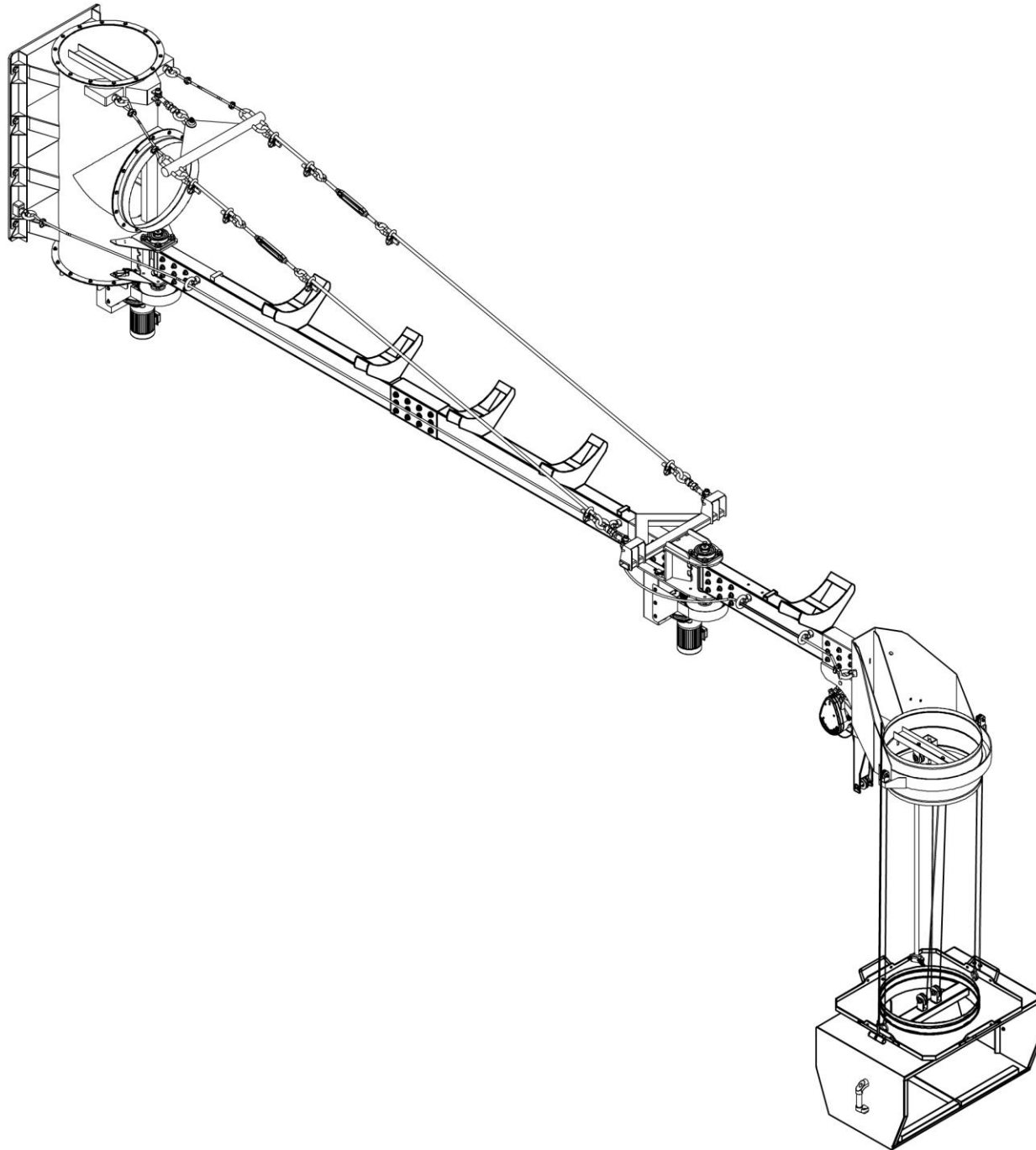

Main Parts Breakdown for BAY-2

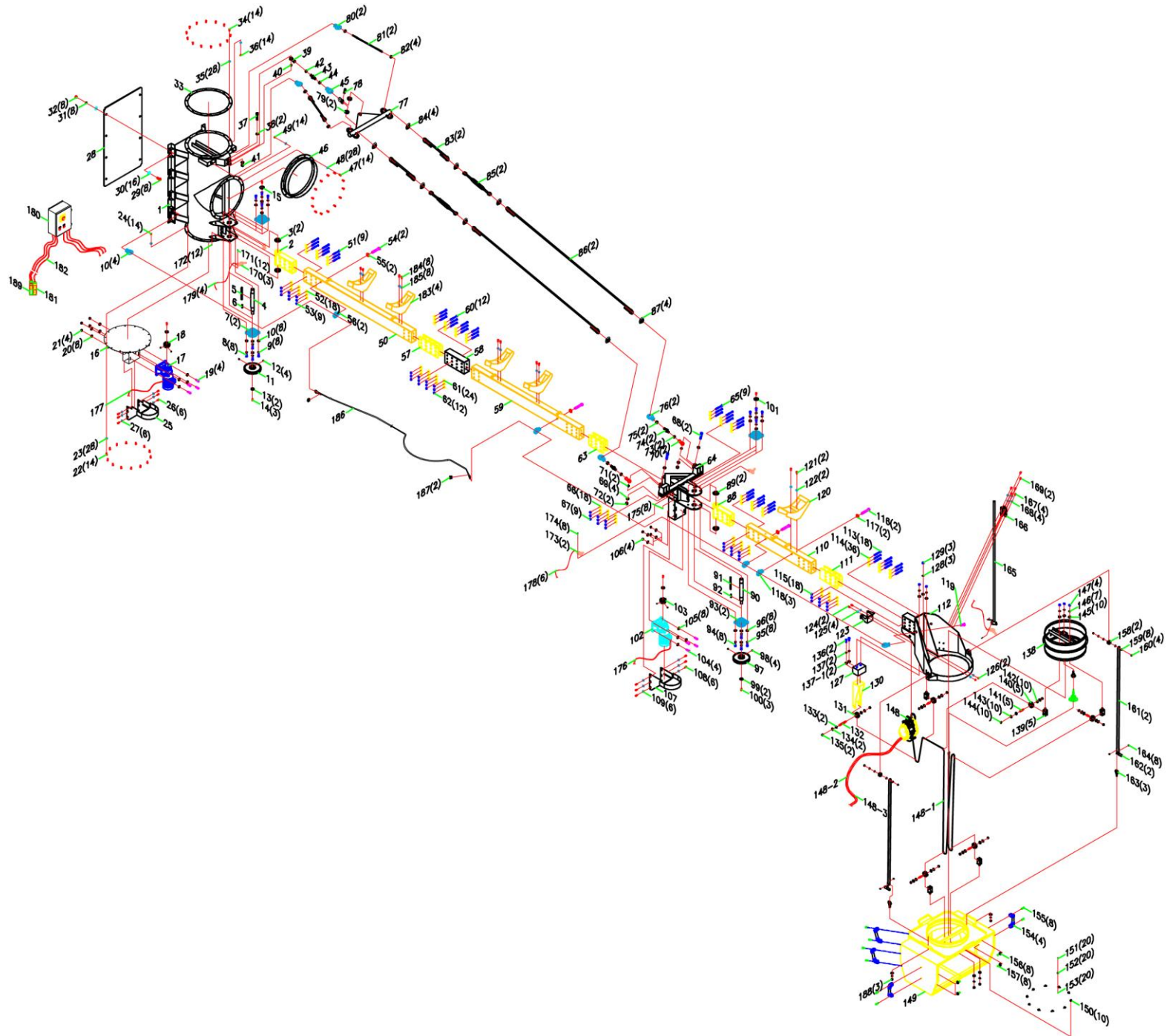

Main Parts Breakdown for BAY-2

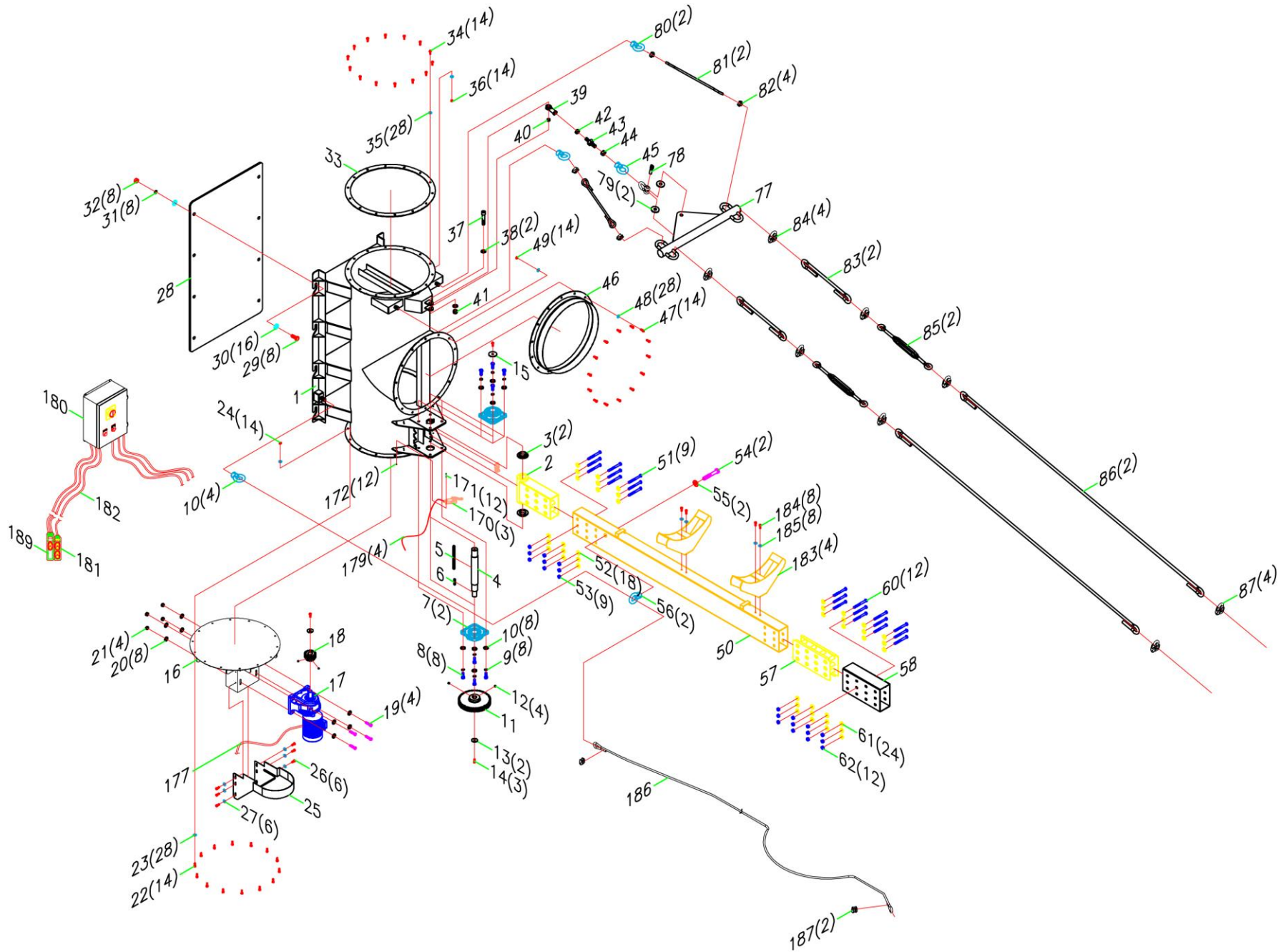

Main Parts Breakdown for BAY-2

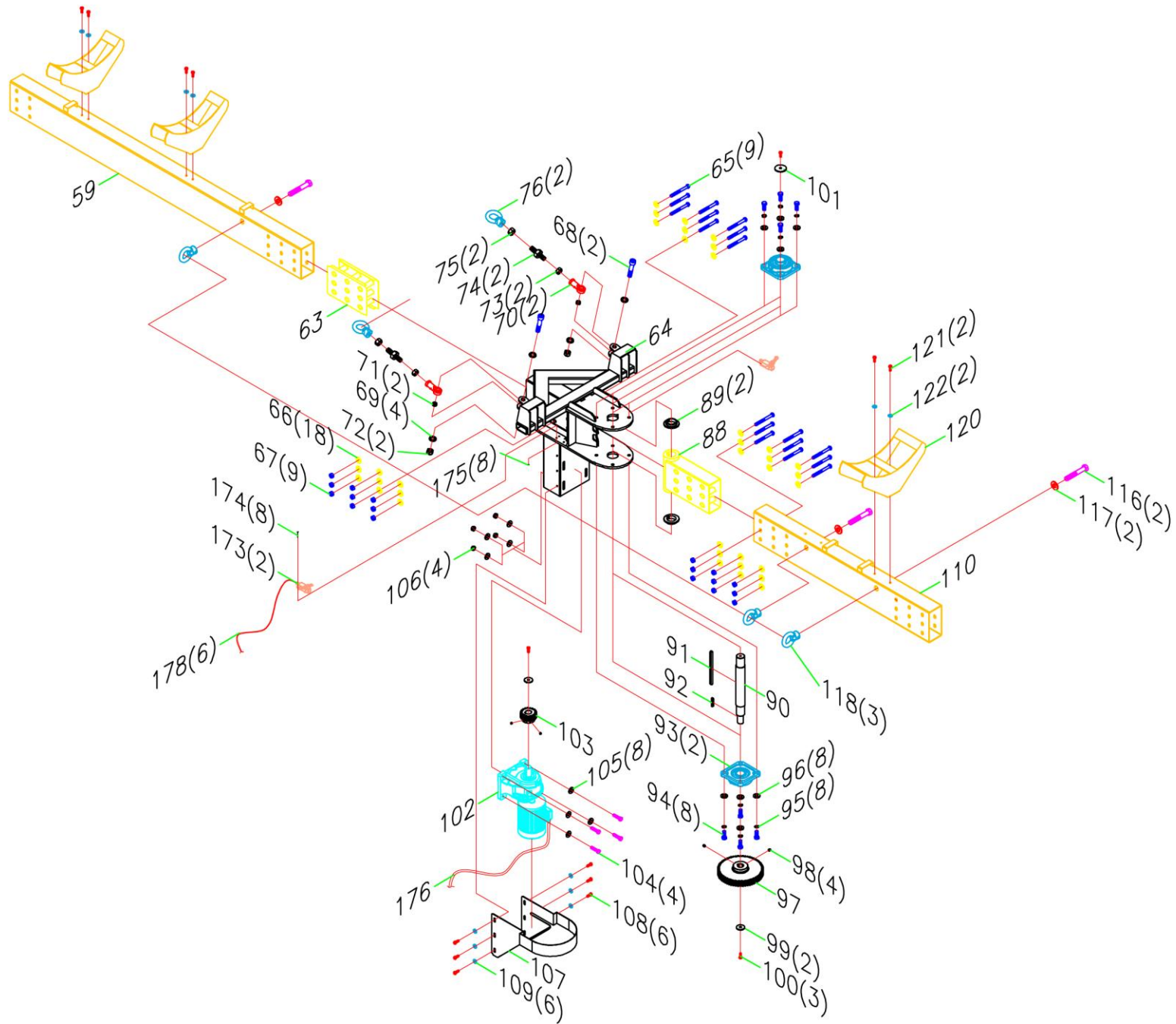

Main Parts Breakdown for BAY-2

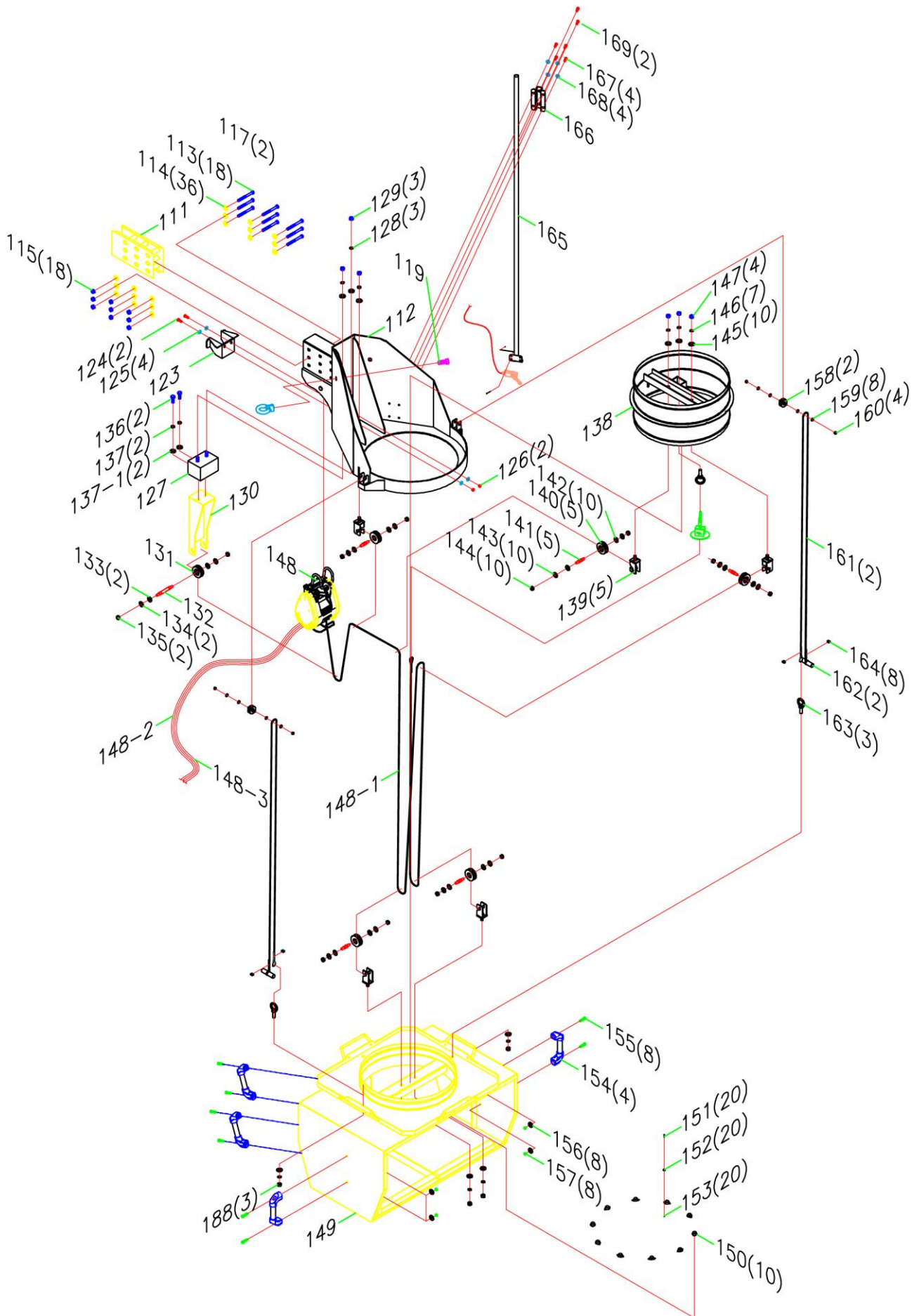

Part List

REF	Part Name	Specification	Q'ty
1	STEEL FRAME	1500 x 763 x 984 mm	1
2	BOOM ROTATION BASE	386 x 226 x ψ 86 mm	1
3	WASHER	ψ 83 x 17 mm	2
4	AXLE	ψ 50 x 440 mm	1
5	KEY STOCK	14 x 9 x 220	1
6	KEY STOCK	10 x 8 x 54	1
7	BEARING	UCF309	2
8	HEX SCREW	5/8" x 1-1/2"	8
9	LOCK WASHER	5/8"	8
10	FLAT WASHER	5/8" x OD40 x 3T	8
11	BIG GEAR	ψ 240 x 32	1
12	FLAT HEAD SCREW	3/8" x 15mm	4
13	WASHER	ψ 45 x 4T	2
14	HEX SCREW	3/8" x 3/4"	3
15	WASHER	ψ 62 x 4T	1
16	MOTOR BASE	ψ 690 x 323	1
17	MOTOR 1	1/2000	1
18	SMALL GEAR	ψ 80 x 32	1
19	HEX SCREW	1/2" x 2"	4
20	FLAT WASHER	1/2" x OD34 x 3T	8
21	HEX NUT	1/2"	4
22	HEX SCREW	3/8" x 3/4"	14
23	FLAT WASHER	3/8" x OD23 x 2T	28

Part List

REF	Part Name	Specification	Q'ty
24	HEX NUT	3/8"	14
25	SAFETY COVER	447 x 284 x 272 mm	1
26	HEX SCREW	3/8" x 3/4"	6
27	FLAT WASHER	3/8" x OD23 x 2T	6
28	FIXER PLATE	1400 x 780 x 12 mm	1
29	HEX SCREW	3/4" x 2"	8
30	FLAT WASHER	3/4" x OD37 x 3T	16
31	LOCK WASHER	3/4"	8
32	HEX NUT	3/4"	8
33	FLANGE (24")	ψ 690 x 5T	1
34	HEX SCREW	3/8" x 3/4"	14
35	FLAT WASHER	3/8" x OD23 x 2T	28
36	HEX NUT	3/8"	14
37	CAP SCREW	M20 x 100mm	1
38	FLAT WASHER	3/4" x OD37 x 3T	1
39	SPHERICAL ROD ENDS	PHS-20	1
40	BEARING	MB2010	1
41	NYLON LOCK NUT	M20	1
42	HEX NUT	M20 (P1.5)	1
43	HEX SCREW	M22 x 105 x M20	1
44	HEX NUT	M22	1
45	EYE NUT	M22	1
46	FLEXIBLE PIPE CONNECTOR	ψ 690 x 100 mm	1

Part List

REF	Part Name	Specification	Q'ty
47	HEX SCREW	3/8" x 3/4"	14
48	FLAT WASHER	3/8" x OD23 x 2T	28
49	HEX NUT	3/8"	14
50	BOOM BASE – 1	100 x 200 x 2228mm	1
51	HALF-THREADED SCREW	1/2" x 5"	9
52	FLAT WASHER	1/2" x OD34 x3T	18
53	HEX NUT	1/2"	9
54	SCREW	M22 x 5-1/2"	2
55	FLAT WASHER	7/8"	2
56	EYE NUT	M22	2
57	INNER CONNECTOR – 3	400 x 190 x 90 mm	1
58	OUTSIDE CONNECTOR – 3	400 x 210 x 110 mm	1
59	BOOM BASE – 2	100 x 200 x 2228mm	1
60	HALF-THREADED SCREW	1/2" x 5"	12
61	FLAT WASHER	1/2" x OD34 x3T	24
62	HEX NUT	1/2"	12
63	INNER CONNECTOR – 2	300 x 190 x 90 mm	1
64	PIVOT CONNECTOR	840 x 720 x 715 mm	1
65	HALF-THREADED SCREW	1/2" x 5"	9
66	FLAT WASHER	1/2" x OD34 x3T	18
67	HEX NUT	1/2"	9
68	CAP SCREW	M20 x 100mm	2
69	FLAT WASHER	3/4" x OD37 x 3T	4

Part List

REF	Part Name	Specification	Q'ty
70	SPHERICAL ROD ENDS	PHS-20	2
71	BEARING	MB2010	2
72	NYLON LOCK NUT	M20	2
73	HEX NUT	M20 (P1.25)	2
74	SCREW	M22 x 105 x M20	2
75	HEX NUT	M22	2
76	EYE NUT	M22	2
77	HANGING BASE	840 x 350 x ψ 608 mm	1
78	BULK SHACKLES	5/8" x 3.25	1
79	WASHER	ψ 61 x 6T	2
80	EYE NUT	M22	2
81	SAFETY STEEL CABLE	1/2" x 1M	2
82	WIRE ROPE CLIPS	1/2"	4
83	STEEL ROD – 2	ψ 20 x 566 x 62 mm	2
84	WIRE ROPE CLIPS	1"	4
85	TURN BUCKLE	3/4"	2
86	STEEL ROD – 1	ψ 20 x 2692 x 62 mm	2
87	WIRE ROPE CLIPS	1"	4
88	BOOM ROTATION BASE – 2	386 x 226 x ψ 86 mm	1
89	WASHER – 2	ψ 83 x 17 mm	2
90	AXLE – 2	ψ 50 x 440 mm	1
91	KEY STOCK	14 x 9 x 220	1
92	KEY STOCK	10 x 8 x 54	1

Part List

REF	Part Name	Specification	Q'ty
93	BEARING	UCF309	2
94	HEX SCREW	5/8" x 1-1/2"	8
95	LOCK WASHER	5/8"	8
96	FLAT WASHER	5/8" x OD40 x 3T	8
97	BIG GEAR	ψ 240 x 32	1
98	FLAT HEAD SCREW	3/8" x 15mm	2
99	WASHER – 2	ψ 45 x 4T	2
100	HEX SCREW	3/8" x 3/4"	3
101	WASHER – 1	ψ 62 x 4T	1
102	MOTOR 2	1/400	1
103	SMALL GEAR	ψ 80 x 32	1
104	HEX SCREW	1/2" x 2"	4
105	FLAT WASHER	1/2" x OD34 x 3T	8
106	HEX NUT	1/2"	4
107	SAFETY COVER	477 x 284 x 272	1
108	HEX SCREW	3/8" x 3/4"	6
109	FLAT WASHER	3/8" x OD23 x 2T	6
110	BOOM BASE	100 x 200 x 1340 mm	1
111	INNER CONNECTOR – 1	370 x 190 x 90 mm	1
112	ELBOW BASE	1260 x 720 x 620 mm	1
113	HALF-THREADED SCREW	1/2" x 5"	18
114	FLAT WASHER	1/2" x OD34 x 3T	36
115	HEX NUT	1/2"	18

Part List

REF	Part Name	Specification	Q'ty
116	SCREW	M22 x 5-1/2"	2
117	FLAT WASHER	7/8"	2
118	EYE NUT	M22	3
119	SCREW	M22 x 2"	1
120	PIPE BASE	481 x 180 x 235 mm	1
121	HEX SCREW	3/8" x 3/4"	2
122	FLAT WASHER	3/8" x OD23 x 2T	2
123	HANGING BASE	110 x 110 x 104	1
124	HEX SCREW	3/8" x 1"	2
125	FLAT WASHER	3/8" x OD23 x 2T	4
126	HEX NUT	3/8"	2
127	WHEEL BASE	160 x 100 x 110 mm	1
128	LOCK WASHER	5/8"	3
129	HEX NUT	5/8"	3
130	WHEEL BASE	431 x 130 x 112 mm	1
131	CASTERS	3"	1
132	AXLE	ψ 17 x 140 mm	1
133	EXTERNAL RETAINING RING	E15	2
134	FLAT WASHER	1/2" x OD34 x 3T	2
135	HEX NUT	M12	2
136	HEX SCREW	5/8" x 2"	2
137	LOCK WASHER	5/8"	2
137-1	FLAT WASHER	5/8" x OD40 x 3T	2

Part List

REF	Part Name	Specification	Q'ty
138	FLEXIBLE HOSE CONNECTOR	ψ 654 x 310 mm	1
139	STEEL WHEEL	73 x 50 x 50 mm	5
140	CASTERS	3"	5
141	AXLE	ψ 17 x 70 mm	5
142	EXTERNAL RETAINING RING	E15	10
143	FLAT WASHER	1/2" x OD34 x 3T	10
144	HEX NUT	M12	10
145	FLAT WASHER	5/8" x OD40 x 3T	5
146	LOCK WASHER	5/8"	4
147	HEX NUT	5/8"	4
148	MOTOR 3	1.3KW/110V/1PH	1
148-1	SAFETY STEEL CABLE	ψ 5 x 35M	1
148-2	POWER CORD OF MOTOR 3	14AWG x 5C x 1200 mm	1
148-2	CORRUGATED PLASTIC TUBING	1/2" x 1200 mm	1
148-3	CONTROL LINE OF MOTOR 3	14AWG x 5C x 1200 mm	1
148-3	CORRUGATED PLASTIC TUBING	1/2" x 1200 mm	1
149	SUCTION HOOD	1200 x 868 x 868 mm	1
150	BALL TRANSFER	5/8"	10
151	ROUND PHILLIPS HEAD SCREW	M5 x 15 mm	20
152	FLAT WASHER	3/16" x OD12 x 1T	20
153	FLANGE NUT	M5	20
154	ALUMINUM HANDLE	200Lmm	4

Part List

REF	Part Name	Specification	Q'ty
155	CAP SCREW	M10 x 50 mm	8
156	FLAT WASHER	3/8" x OD25 x 3T	8
157	HEX NUT	M10	8
158	WHEEL	2"	2
159	FLAT WASHER	5/16" x OD18 x 2T	8
160	HEX NUT	5/16"	4
161	SAFETY STEEL CABLE	ψ 5mm x 8M	2
162	SAFETY ROD	ψ 25 x 100 mm	2
163	EYE BOLT	M16	3
164	WIRE ROPE CLIPS	ψ 5mm	8
165	LIMIT SWITCH BASE	ψ 27 x 2200 x 80 mm	1
166	BASE FIXER FOR LIMIT SWITCH	160 x 88 x 35 mm	1
167	HEX SCREW	3/8" x 3/4"	4
168	FLAT WASHER	3/8" x OD23 x 2T	4
169	HEX SCREW	3/8" x 3/4"	2
170	LIMIT SWITCH	8108	3
171	ROUND PHILLIPS HEAD SCREW	M5 x 20 mm	12
172	HEX NUT	M5	12
173	LIMIT SWITCH	8108	2
174	ROUND PHILLIPS HEAD SCREW	M5 x 20 mm	8
175	HEX NUT	M5	8
176	POWER CORD OF MOTOR 1	14AWG x 5C x 1100 mm	1

Part List

REF	Part Name	Specification	Q'ty
176	CORRUGATED PLASTIC TUBING	1/2" x 1100 mm	1
177	POWER CORD OF MOTOR 2	14AWG x 5C x 1000 mm	1
177	CORRUGATED PLASTIC TUBING	1/2" x 1000 mm	1
178	CONTROL LINE OF LIMIT SWITCH	20AWG x 1100 mm	6
178	CORRUGATED PLASTIC TUBING	1/4" x 1100 mm	6
179	CONTROL LINE OF LIMIT SWITCH	20AWG x 1000	4
179	CORRUGATED PLASTIC TUBING	1/4" x 1000 mm	4
180	CONTROL BOX	16 x 12 x 08	1
181	PENDANT SWITCH	4 buttons	1
182	CONTROL LINE OF PENDANT SWITCH	14AWG x 5C x 1100 mm	3
183	PIPE BASE	481 x 110 x 235 mm	4
184	HEX SCREW	3/8" x 3/4"	8
185	FLAT WASHER	3/8" x OD23 x 2T	8
186	SAFETY STEEL CABLE	1/2" x 10M	1
187	WIRE ROPE CLIPS	1/2"	4
188	HEX SCREW	M16	3
189	PENDANT SWITCH	2 buttons	1