

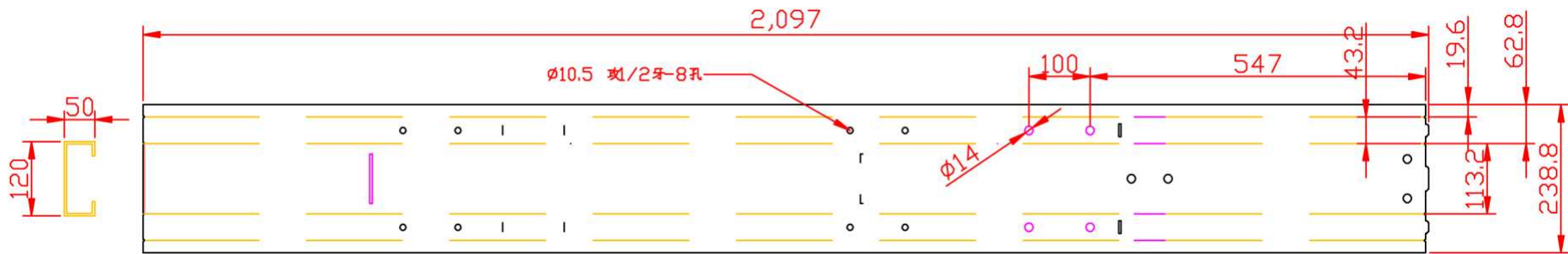

#	Number	Q'ty	Construction gauge steel m/m	Length m/m	Wide m/m	Shaper	A m/m	B m/m
1	1-A	6	4.0	2097	238.8		50	120
	1-B	6	5.0	230	85			

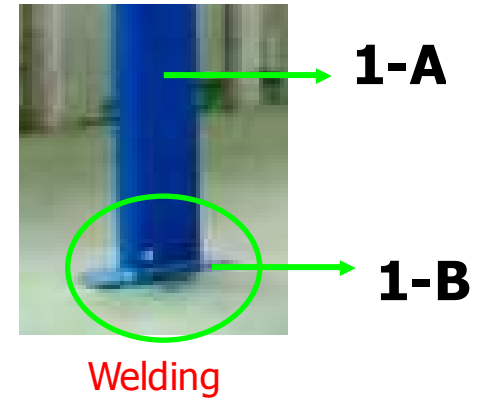

1-A

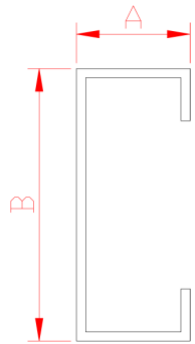
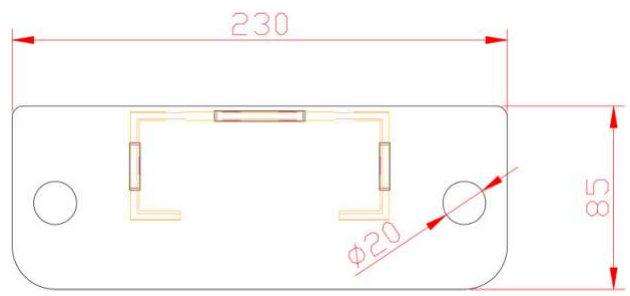

1-B

#	Number	Q'ty	Construction gauge steel m/m	Length m/m	Wide m/m	Shaper	A m/m	B m/m
2	2-A	2	3.0	2450	190.4		50	100

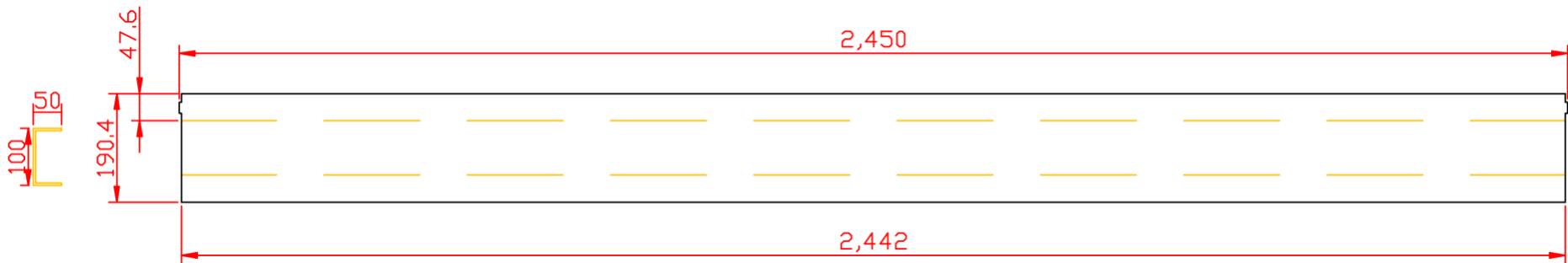
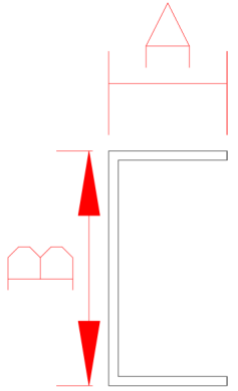

2-A

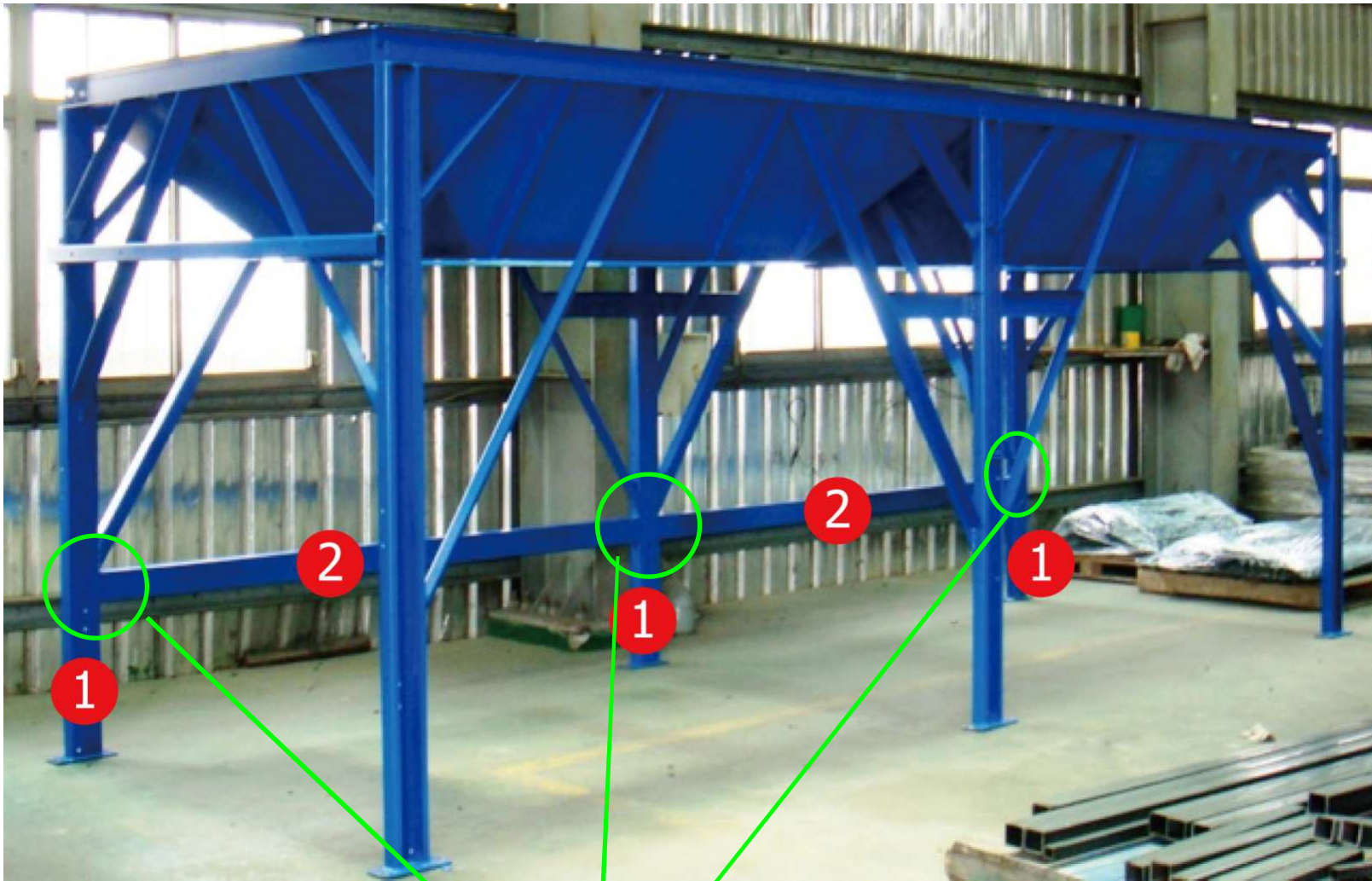

Welding

#	Number	Q'ty	Construction gauge steel m/m	Length m/m	Wide m/m	Shaper	A m/m	B m/m
3	3-A	2	3.0	1725.9	190.4		50	100

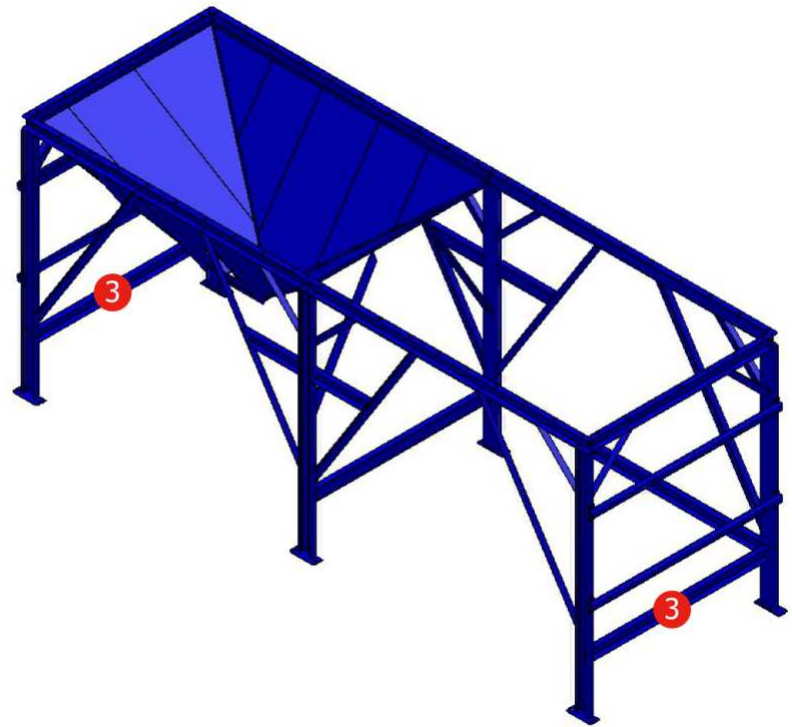
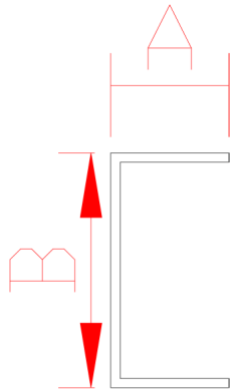

3-A

#	Number	Q'ty	Construction gauge steel m/m	Length m/m	Wide m/m	Shaper	A m/m	B m/m
4	4-A	1	3.0	1725.9	190.4		50	100

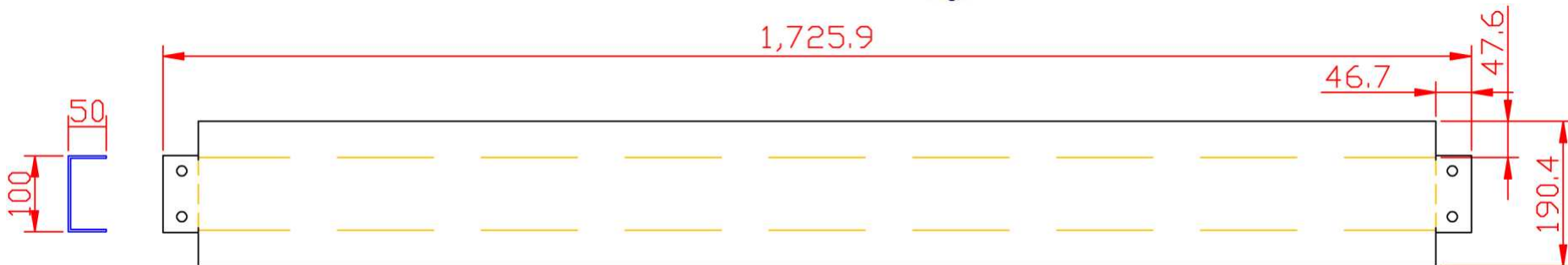
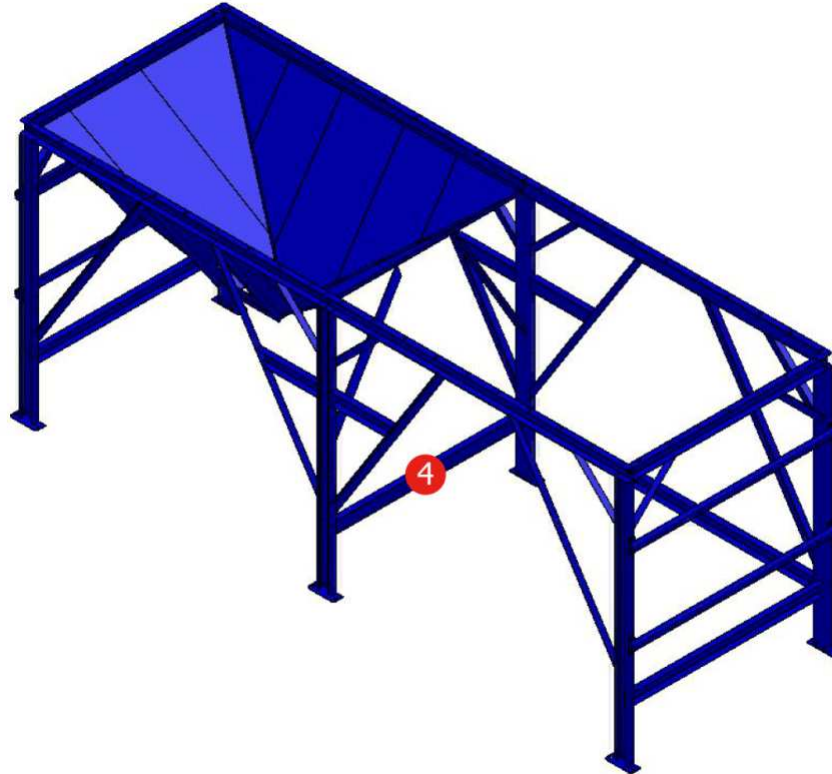
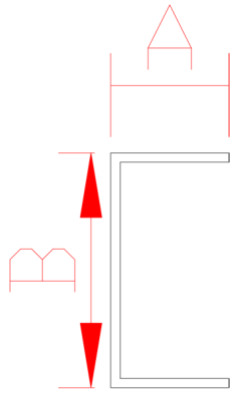

4-A

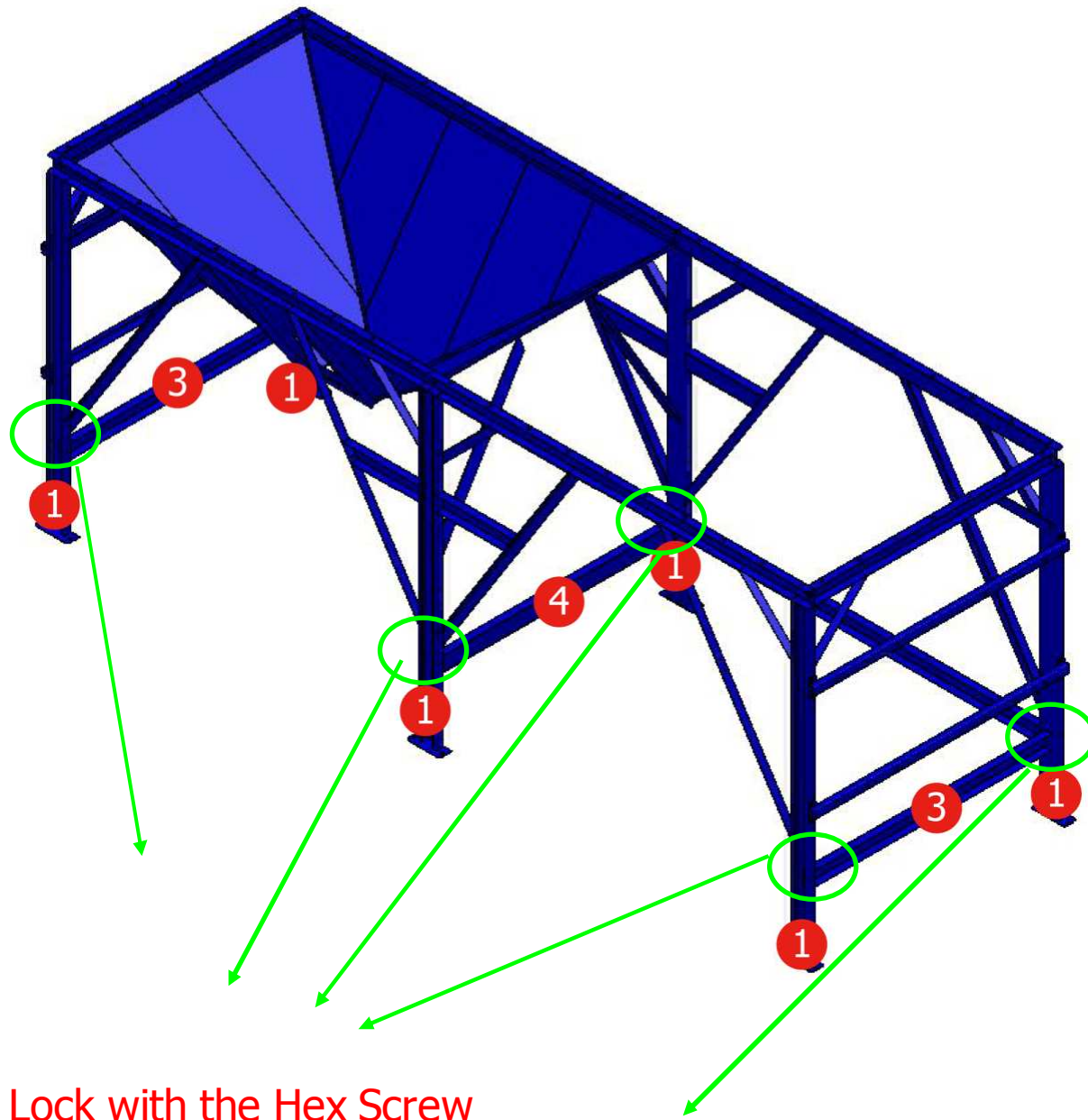

Lock with the Hex Screw

#	Number	Q'ty	Construction gauge steel m/m	Length m/m	Wide m/m	Shaper	A m/m	B m/m
5	5-A	4	4.0	1738.5	103.8		30	58
	5-B	1	4.0	130	50			

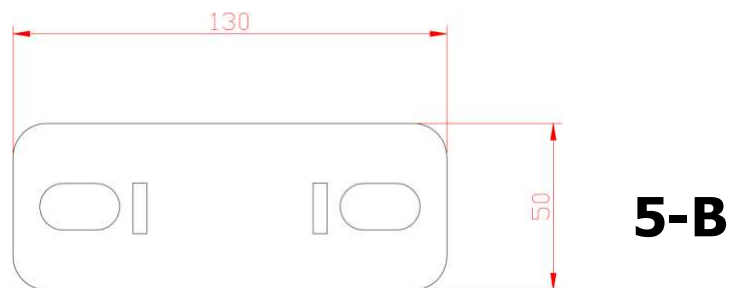
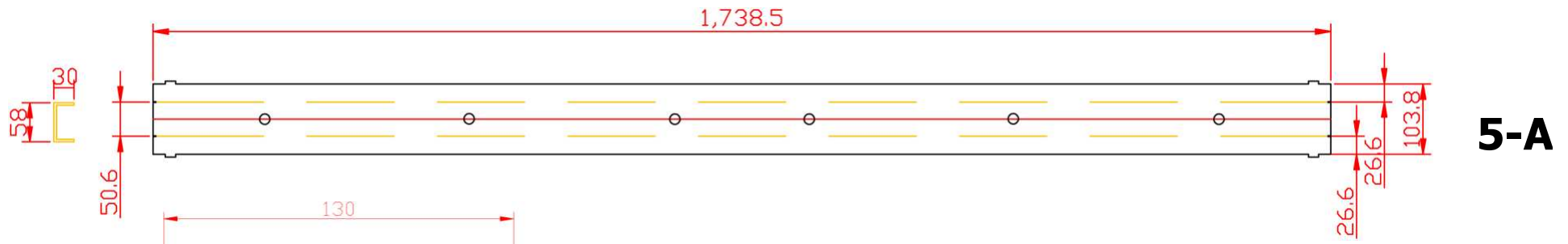
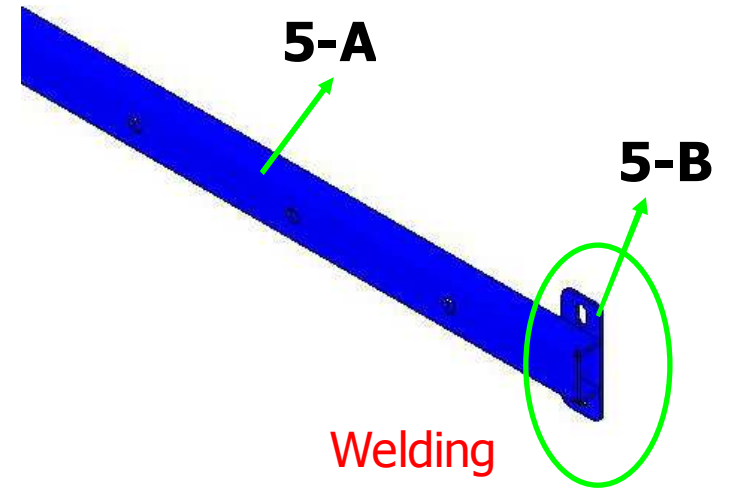
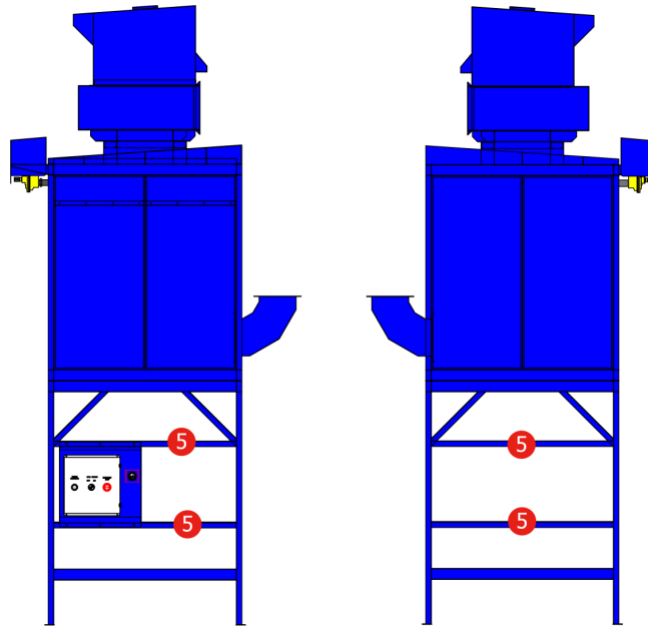
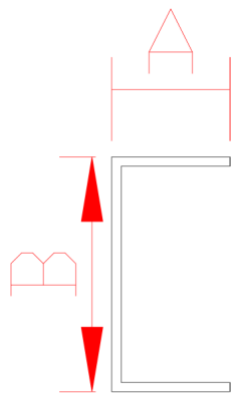

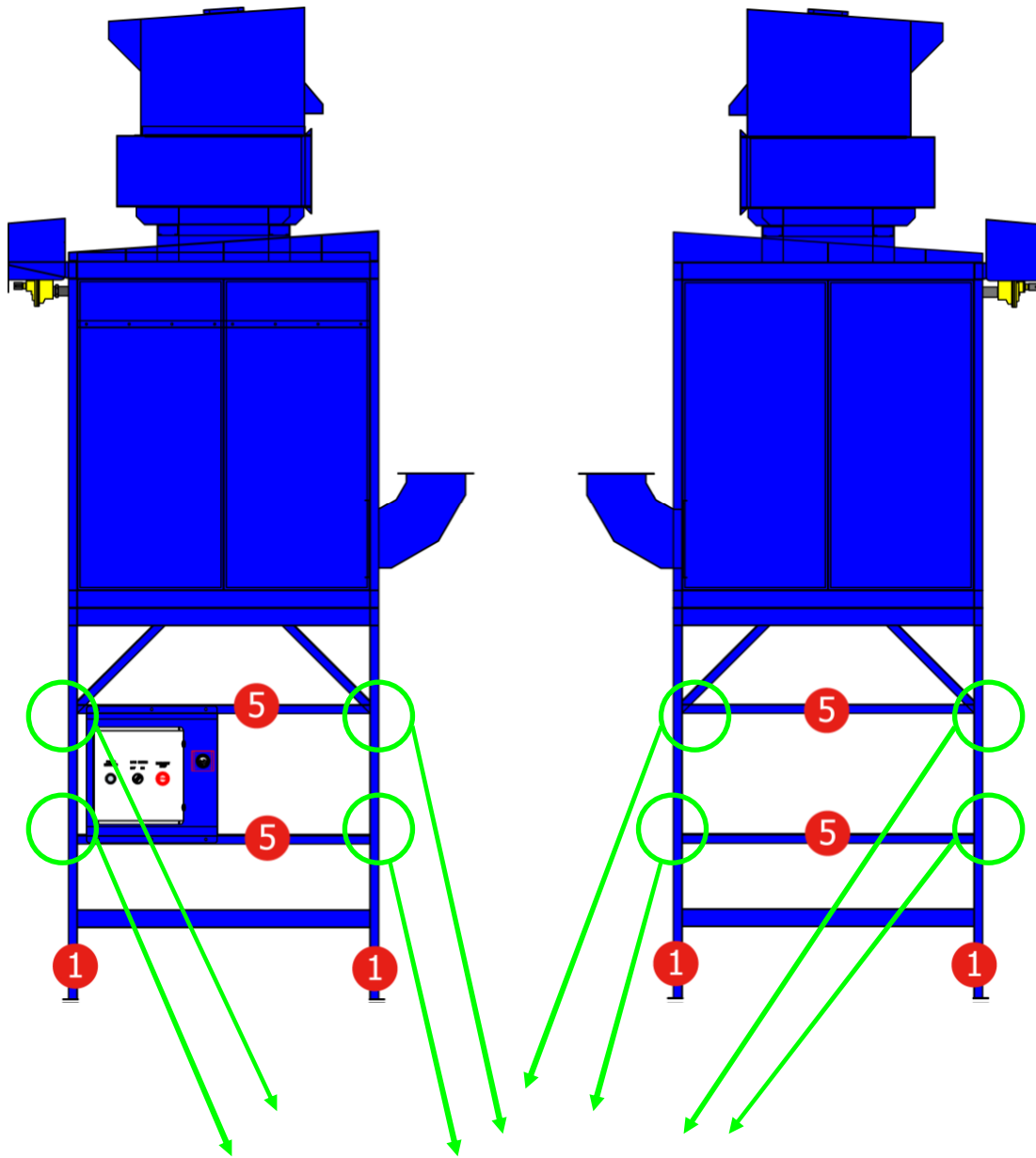

Lock with the Hex Screw

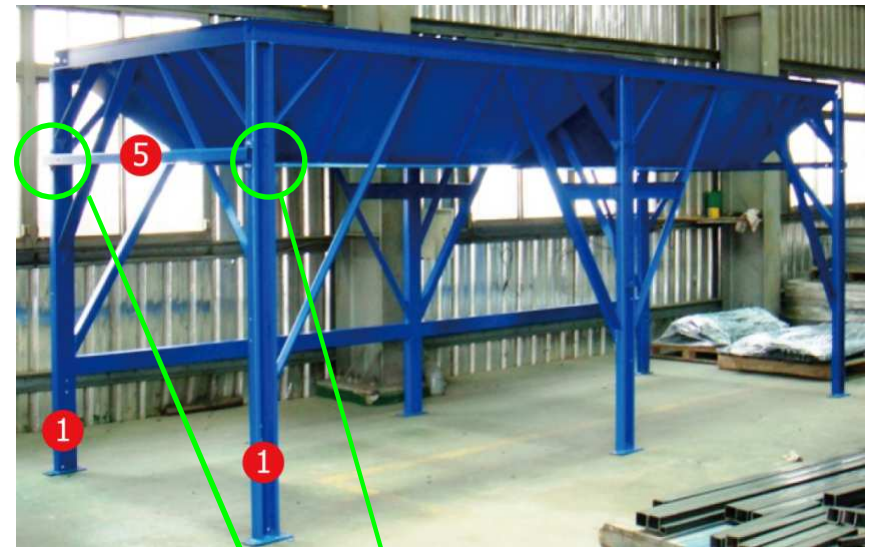

Lock with the Hex Screw

#	Number	Q'ty	Construction gauge steel m/m	Length m/m	Wide m/m	Shaper	A m/m	B m/m
6	6-A	2	4.0	517.18	188		50	100

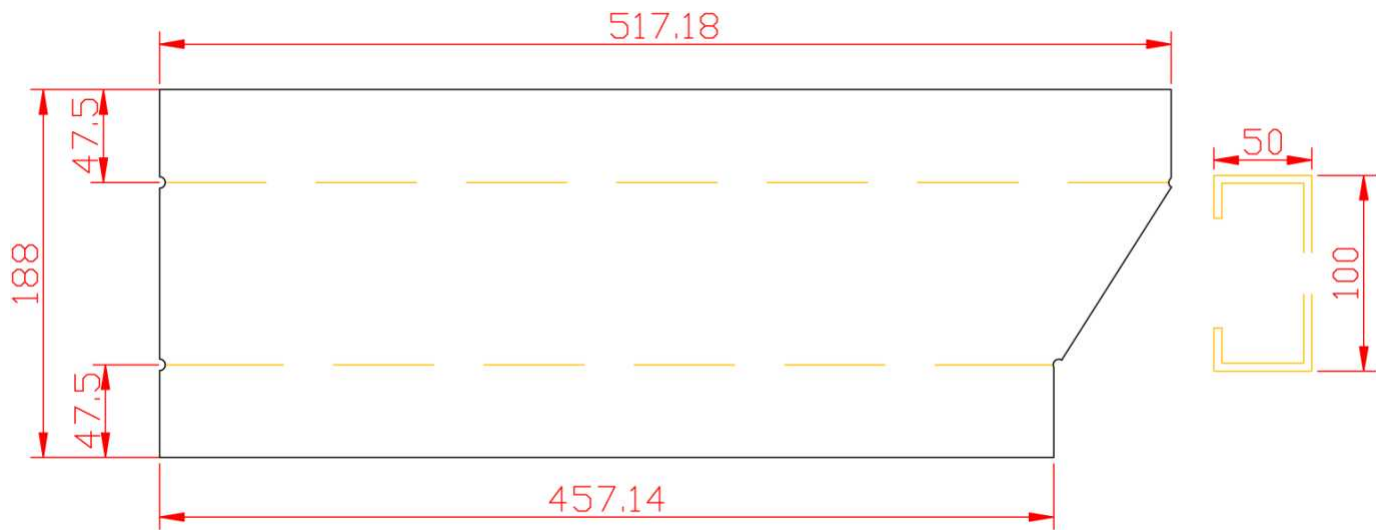
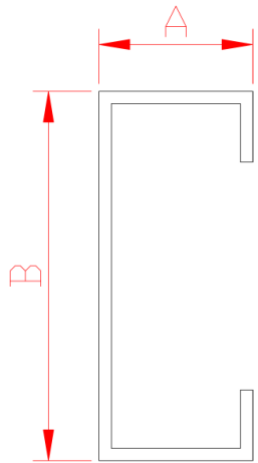

6-A

#	Number	Q'ty	Construction gauge steel m/m	Length m/m	Wide m/m	Shaper	A m/m	B m/m
7	7-A	2	4.0	517.18	188		50	100

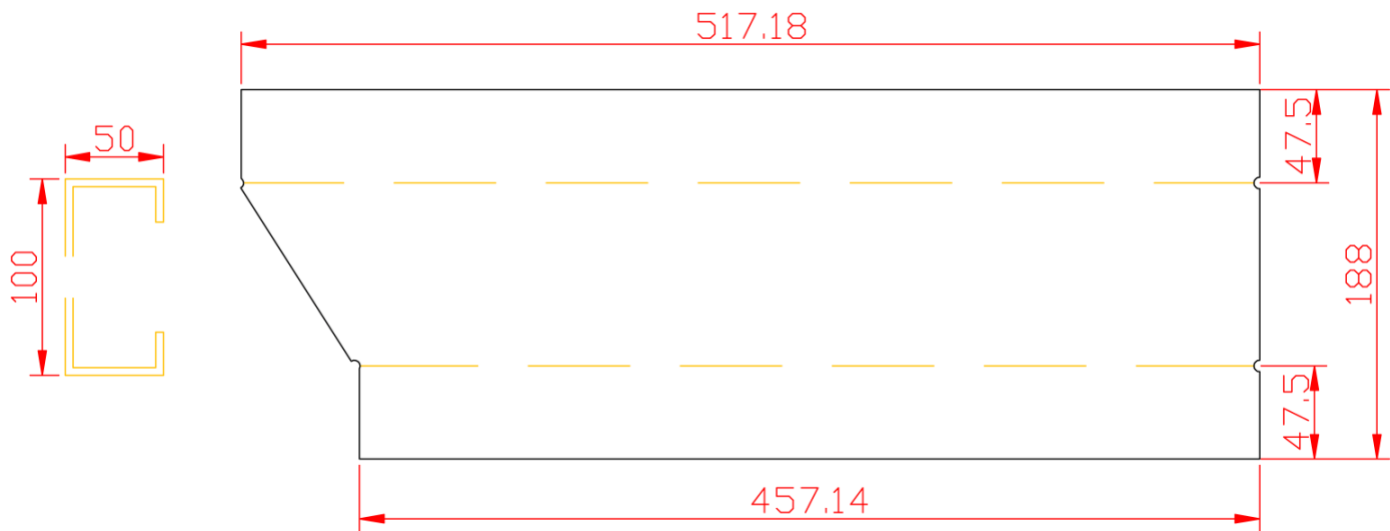
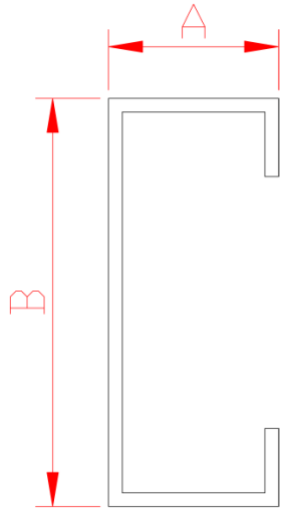

7-A

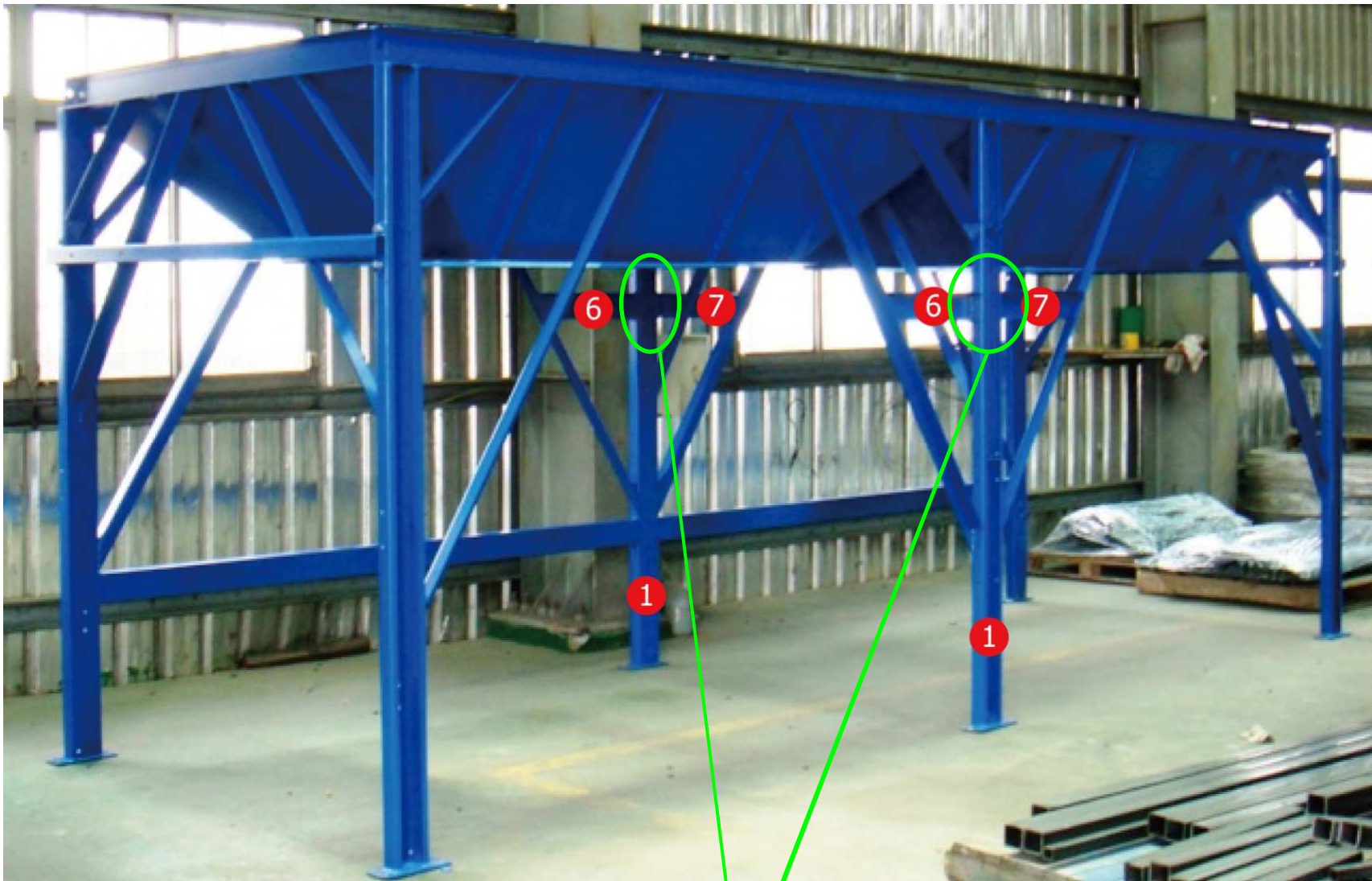

Welding

#	Number	Q'ty	Construction gauge steel m/m	Length m/m	Wide m/m	Shaper	A m/m	B m/m
8	8-A	12	4.0	593	92		43	43

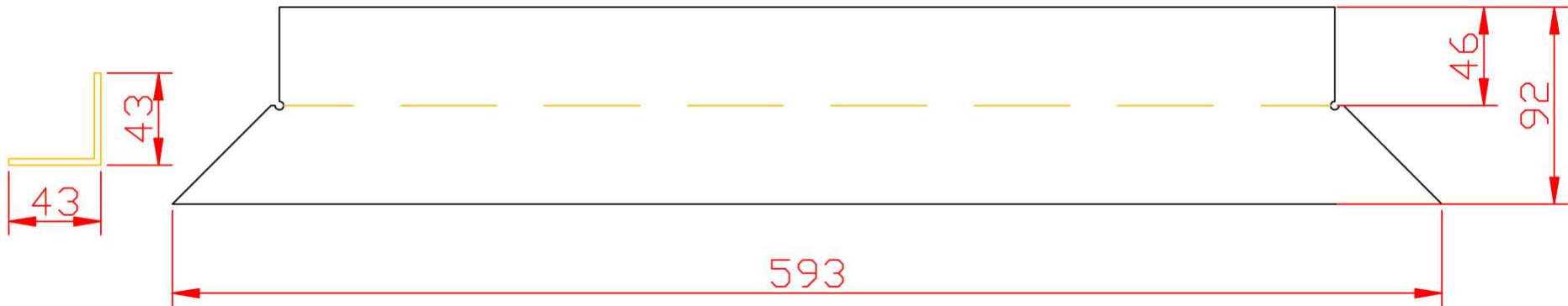
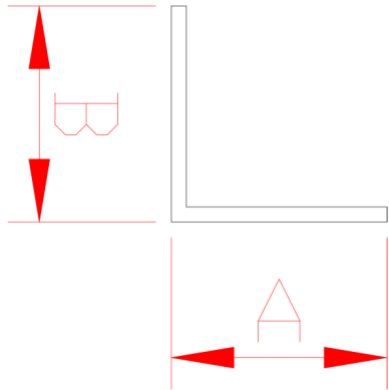

8-A

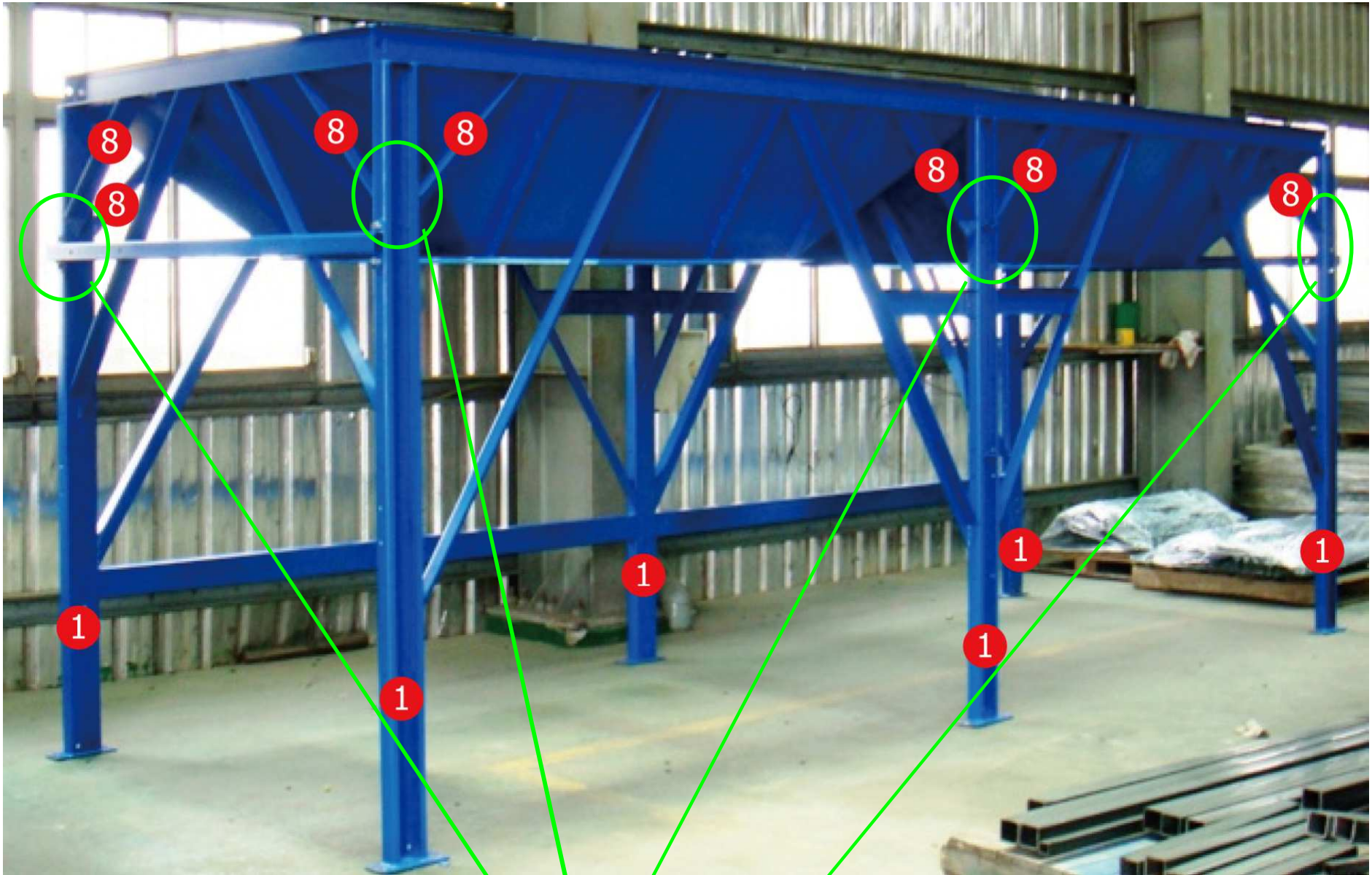

Welding

#	Number	Q'ty	Construction gauge steel m/m	Length m/m	Wide m/m	Shaper	A m/m	B m/m
9	9-A	2	5.0	1773.58	91.2		43	43

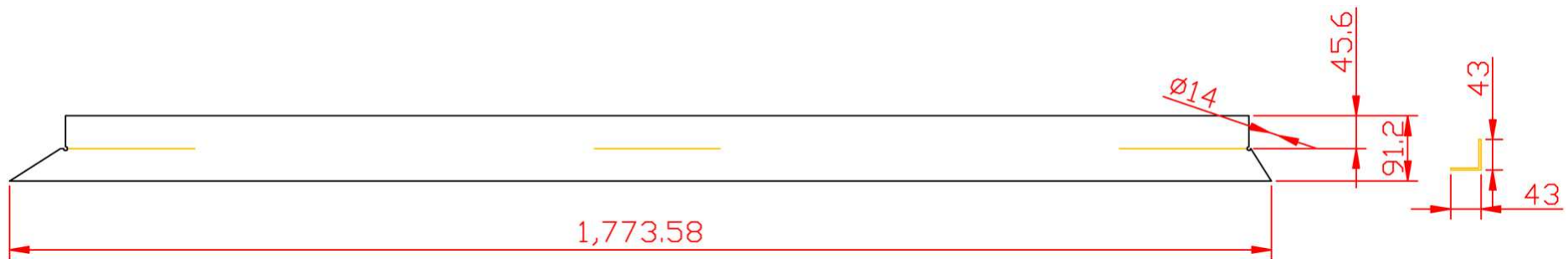
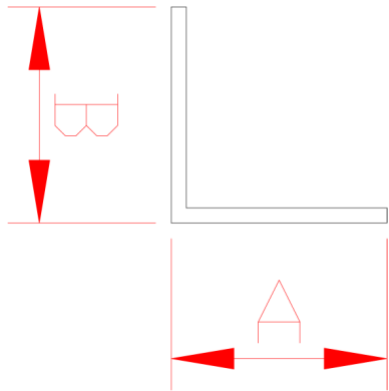

9-A

#	Number	Q'ty	Construction gauge steel m/m	Length m/m	Wide m/m	Shaper	A m/m	B m/m
10	10-A	2	5.0	1773.58	91.2		43	43

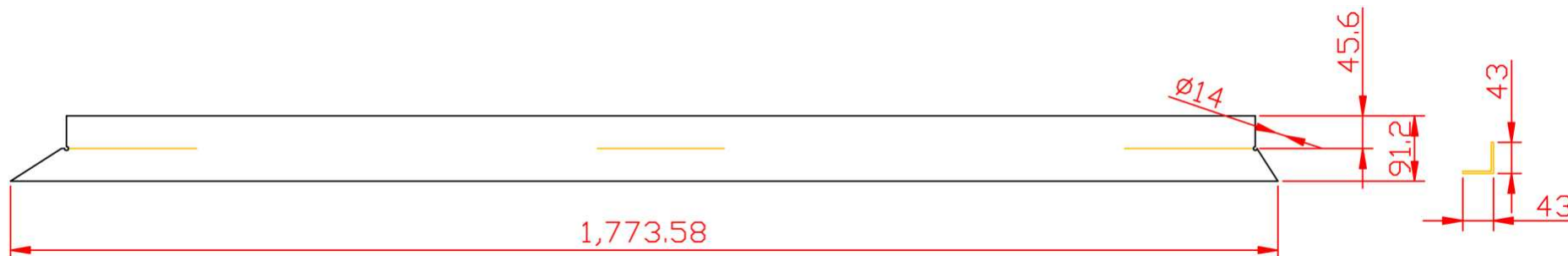
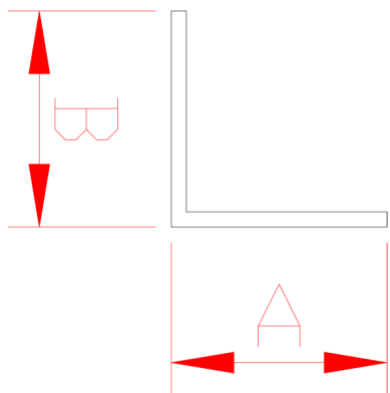

10-A

#	Number	Q'ty	Construction gauge steel m/m	Length m/m	Wide m/m	Shaper	A m/m	B m/m
11	11-A	2	5.0	1773.58	91.2		43	43

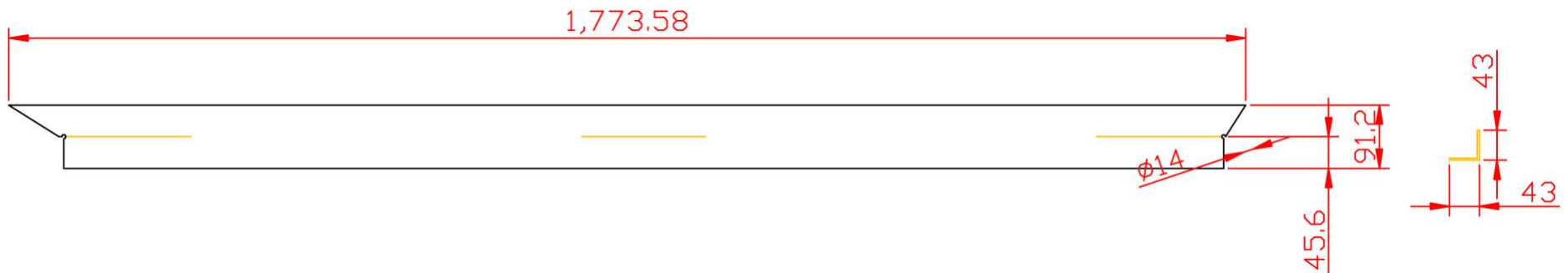
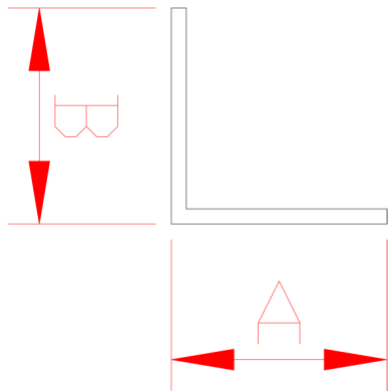

11-A

#	Number	Q'ty	Construction gauge steel m/m	Length m/m	Wide m/m	Shaper	A m/m	B m/m
12	12-A	2	5.0	1773.58	91.2		43	43

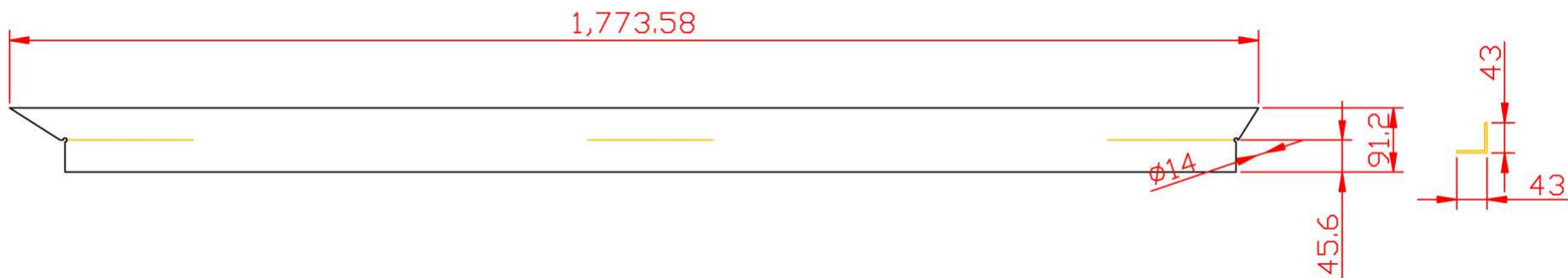
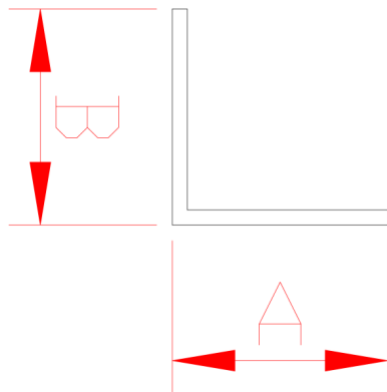

12-A

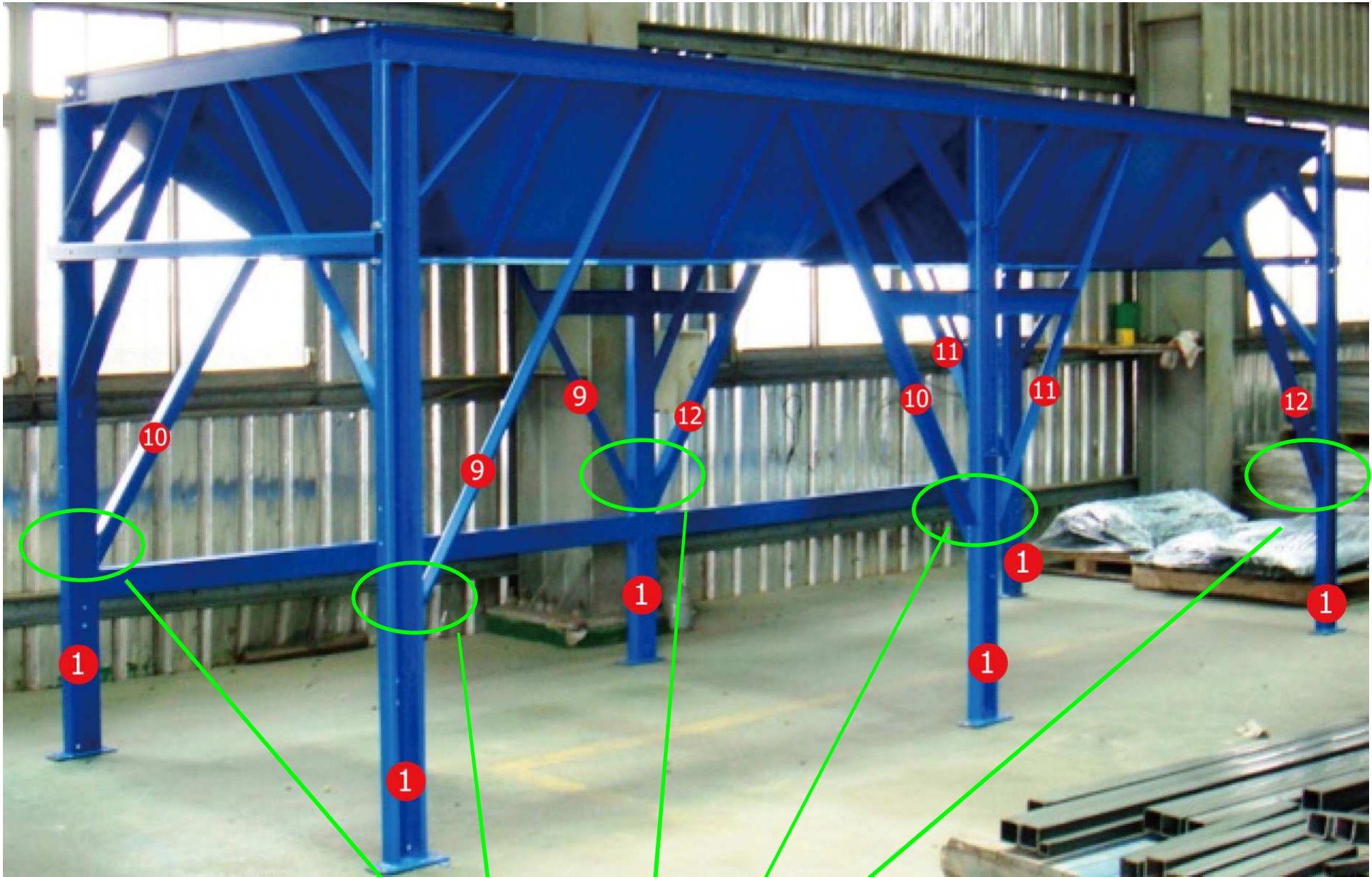

Welding

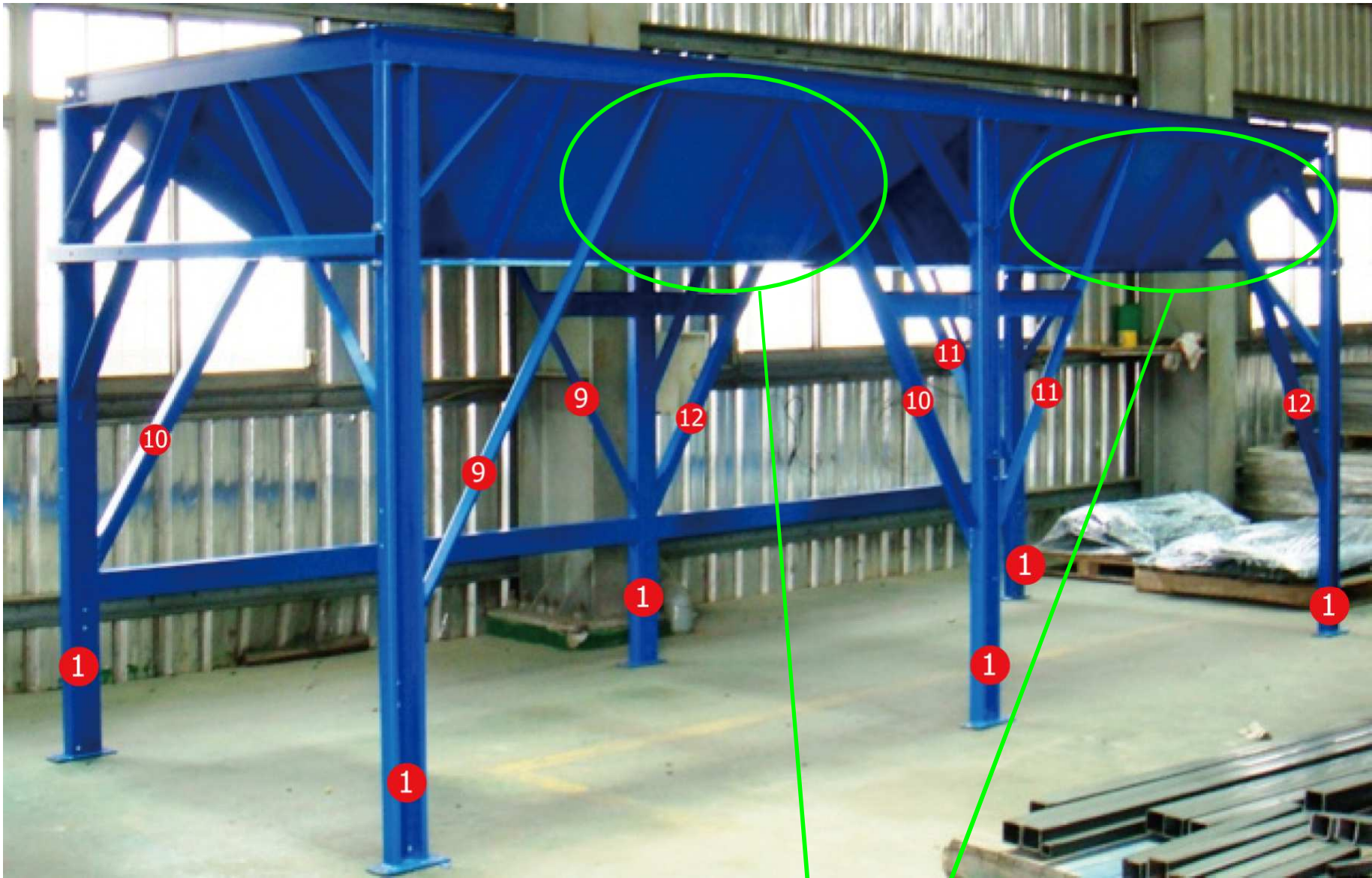

Welding

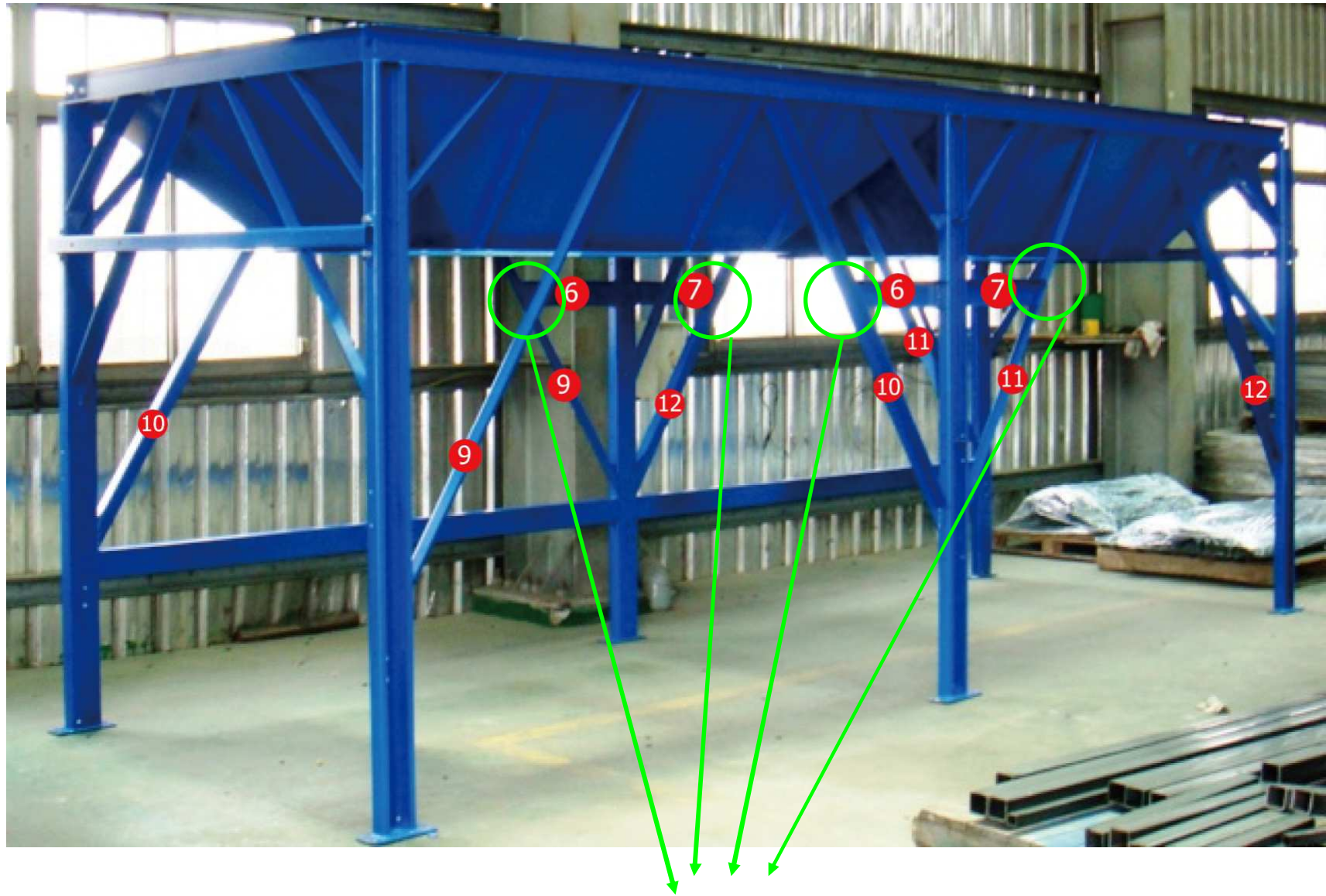

Welding

#	Number	Q'ty	Construction gauge steel m/m	Length m/m	Wide m/m	Shaper	A m/m	B m/m
13	13-A	2	5.0	1564.13	91.2		43	43

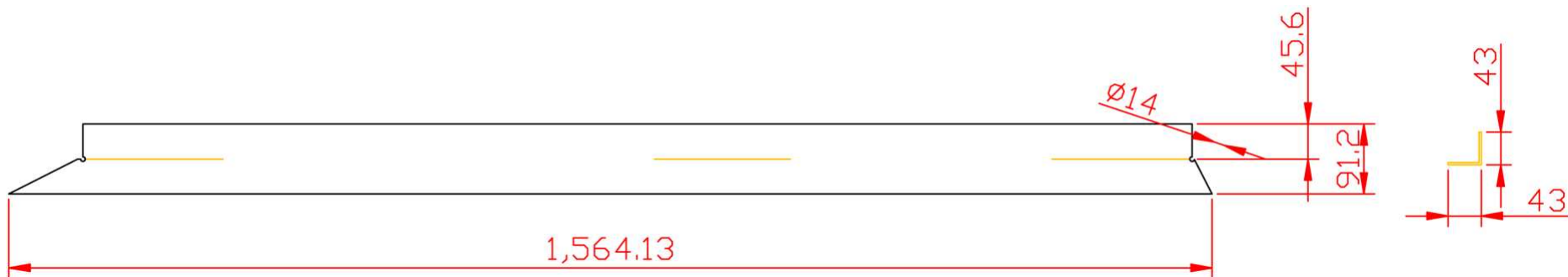
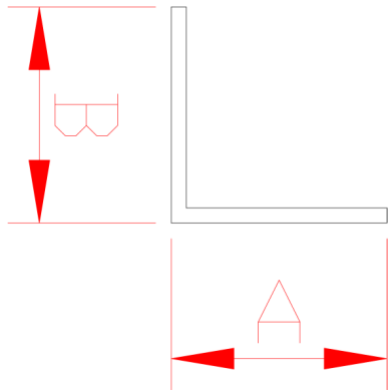

13-A

#	Number	Q'ty	Construction gauge steel m/m	Length m/m	Wide m/m	Shaper	A m/m	B m/m
14	14-A	2	5.0	1564.13	91.2		43	43

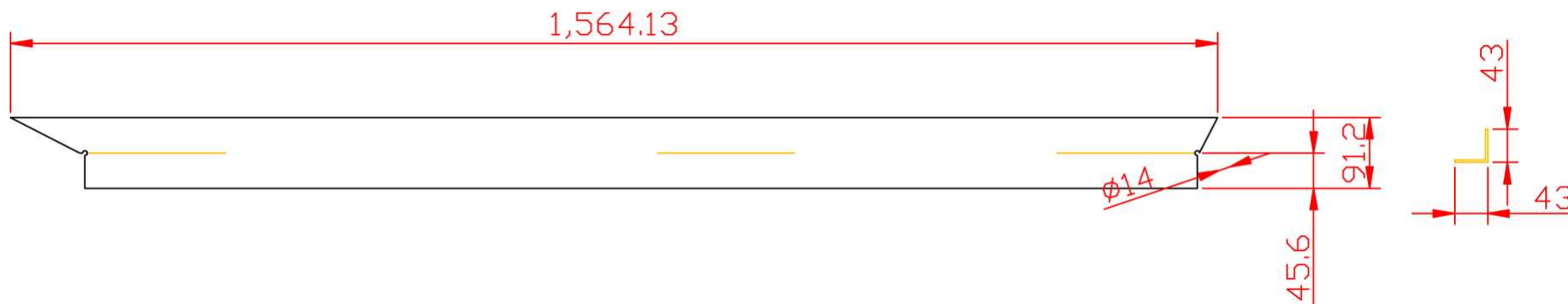
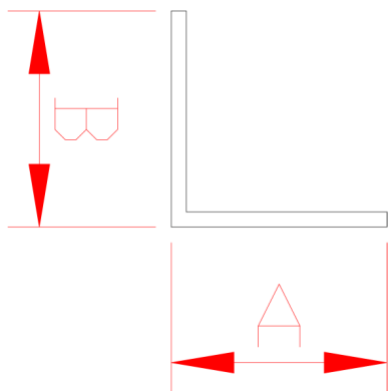

14-A

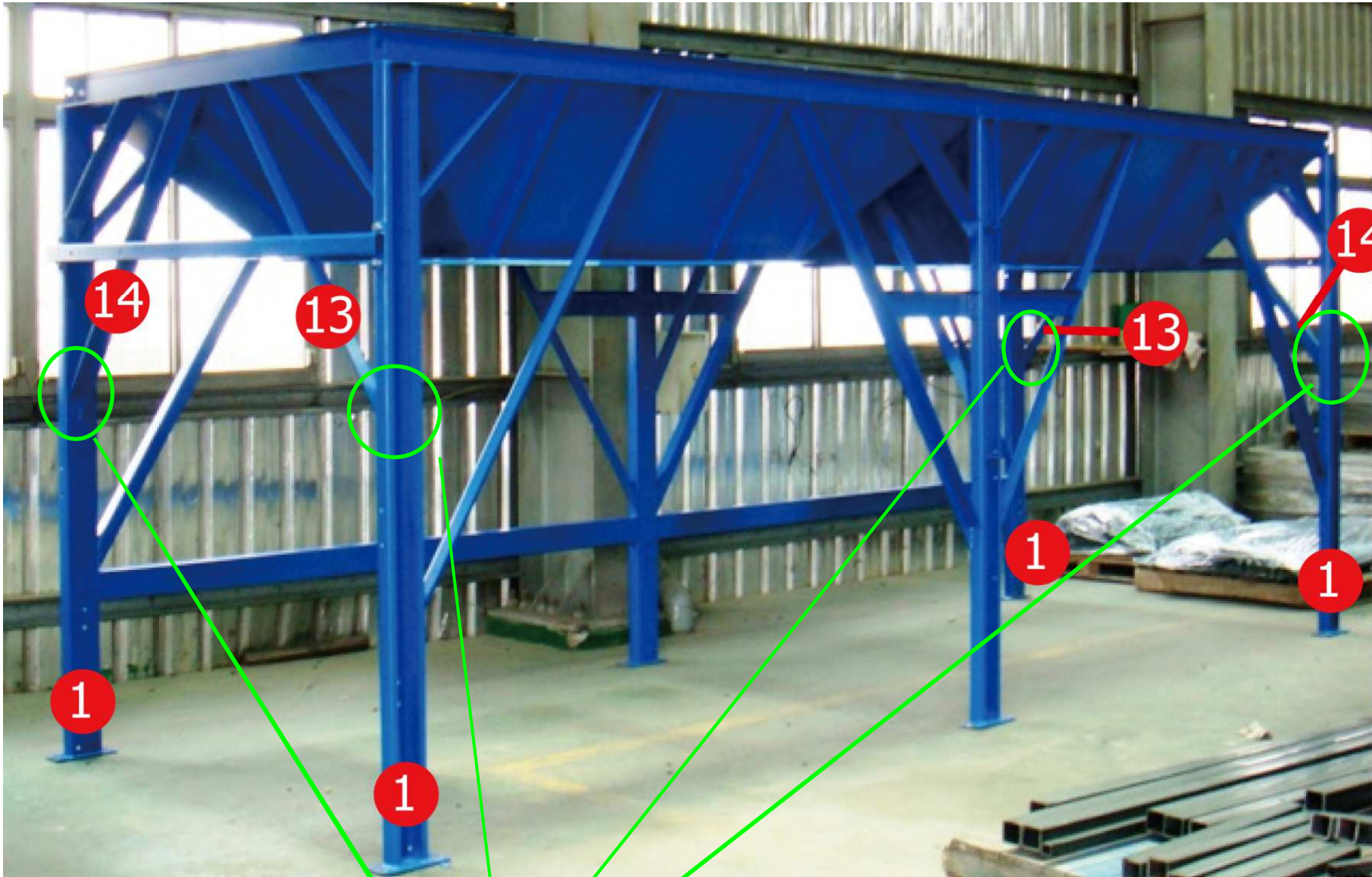

Welding

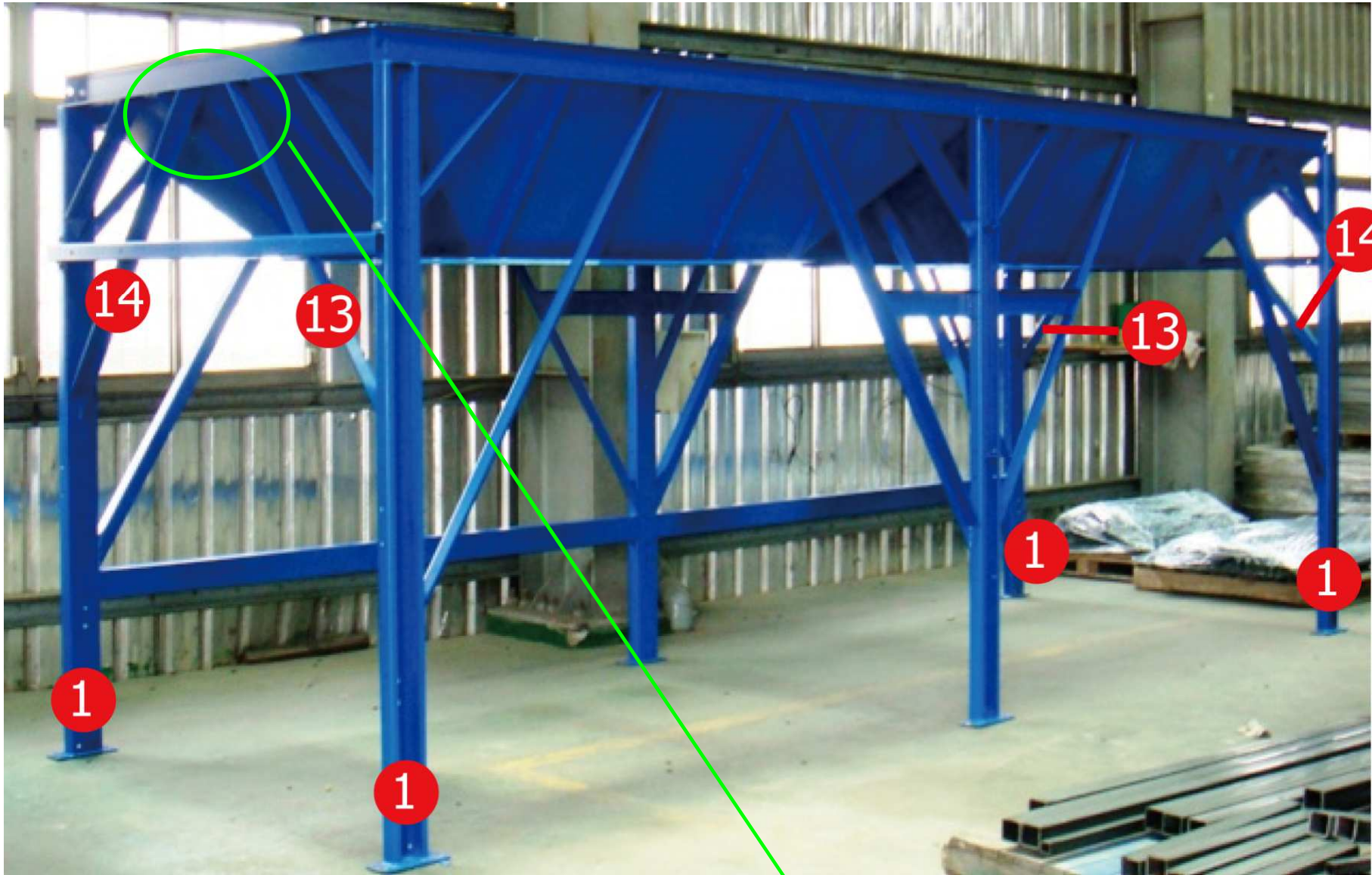

Welding

#	Number	Q'ty	Construction gauge steel m/m	Length m/m	Wide m/m	Shaper	A m/m	B m/m
15	15-A	2	5.0	1175.69	91.2		50	50

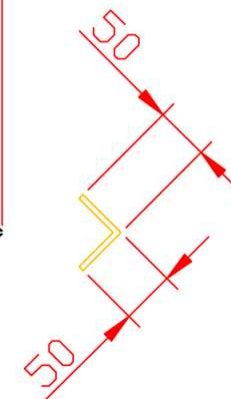
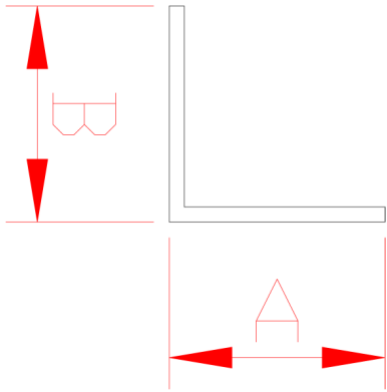

15-A

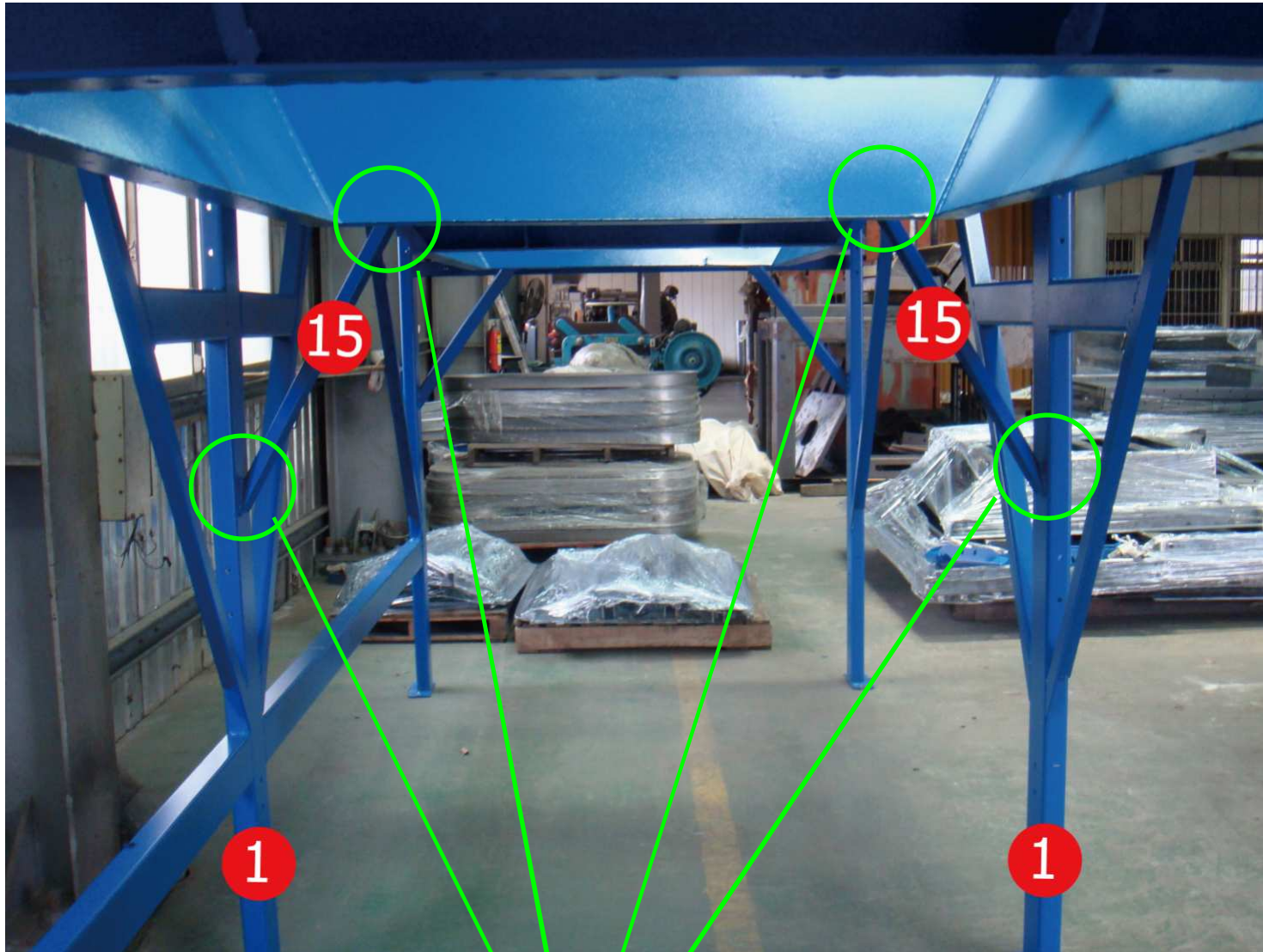

Welding