

#	Date

NO.	DESCRIPTION

NOTES:
 1. DRY SYSTEM HAS NO SLOPE. ALL DUCT AT SAME CENTERLINE ELEVATION.
 2. ALL CONCENTRIC REDUCERS.

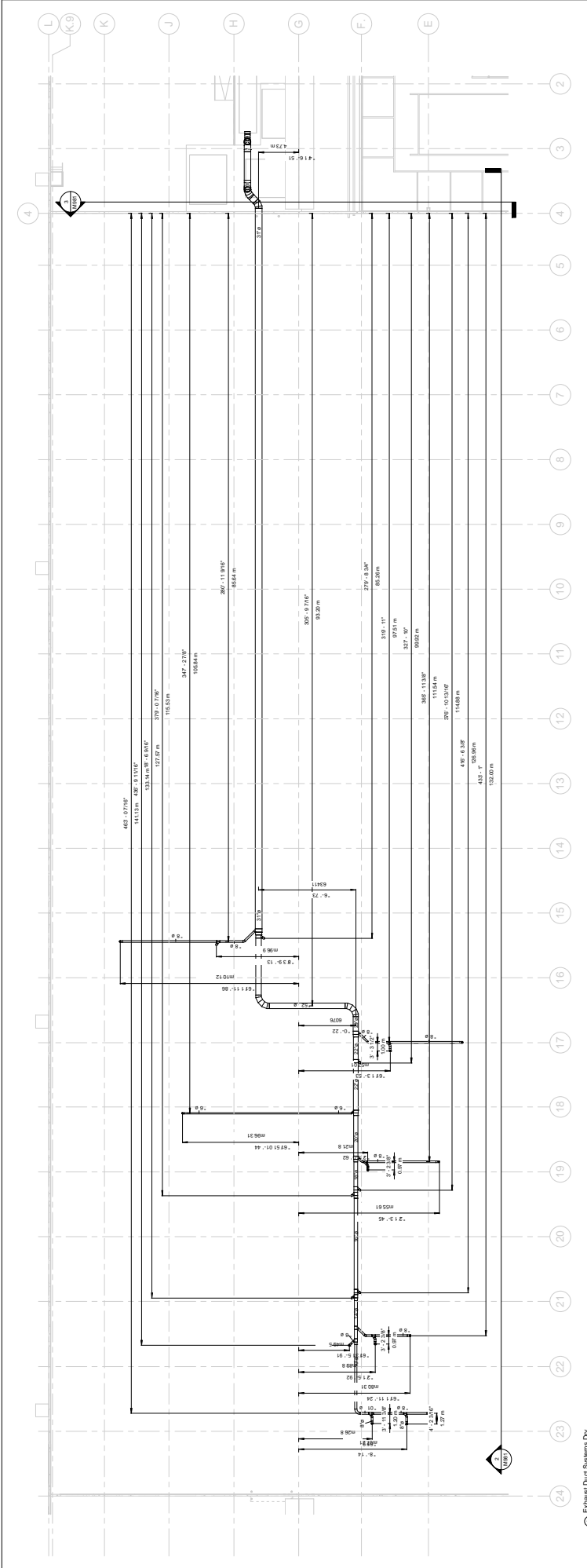

1 Exhaust Duct System 1
1/8" = 1'-0"

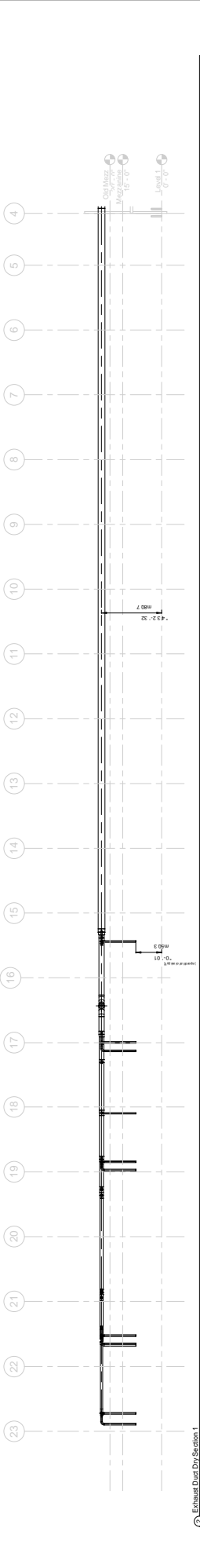

2 Exhaust Duct System 2
1/8" = 1'-0"

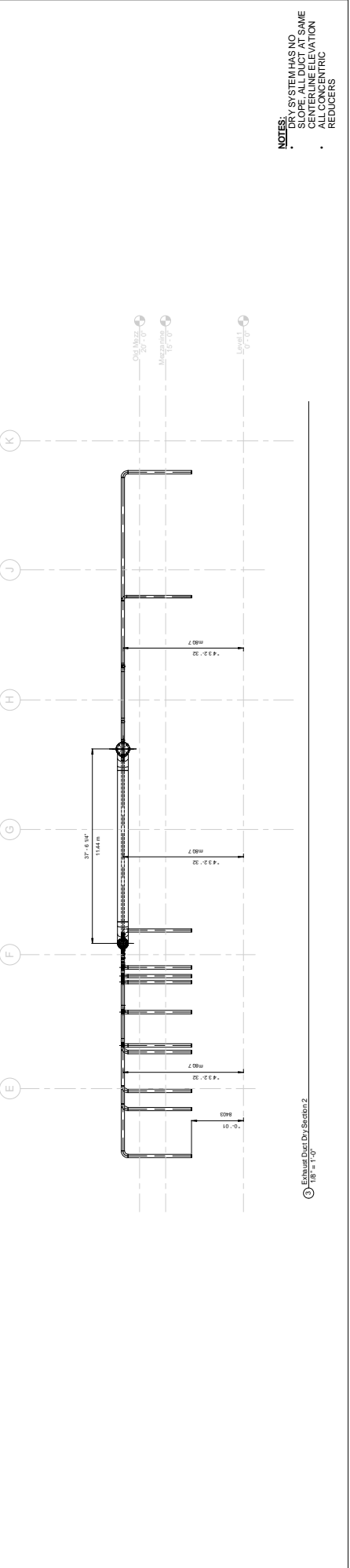

3 Exhaust Duct System 2
1/8" = 1'-0"

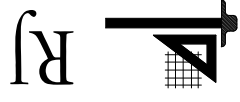

#	Date

PROJECT: N. RITTR WOOD REUF
CLIENT: J. Press Ma n T
DATE: 08/20/2013

NOTES:
 GRINDING SYSTEM HAS
 SLOPE OF 1%
 ALL ELECTRICAL WORKERS
 SHALL BE PROVIDED WITH
 PROTECTIVE GEAR
 ONLY DUCT ELEVATIONS
 SHOULD BE CALCULATED
 BASED ON SLOPE FROM
 WALL OPENINGS AT C4

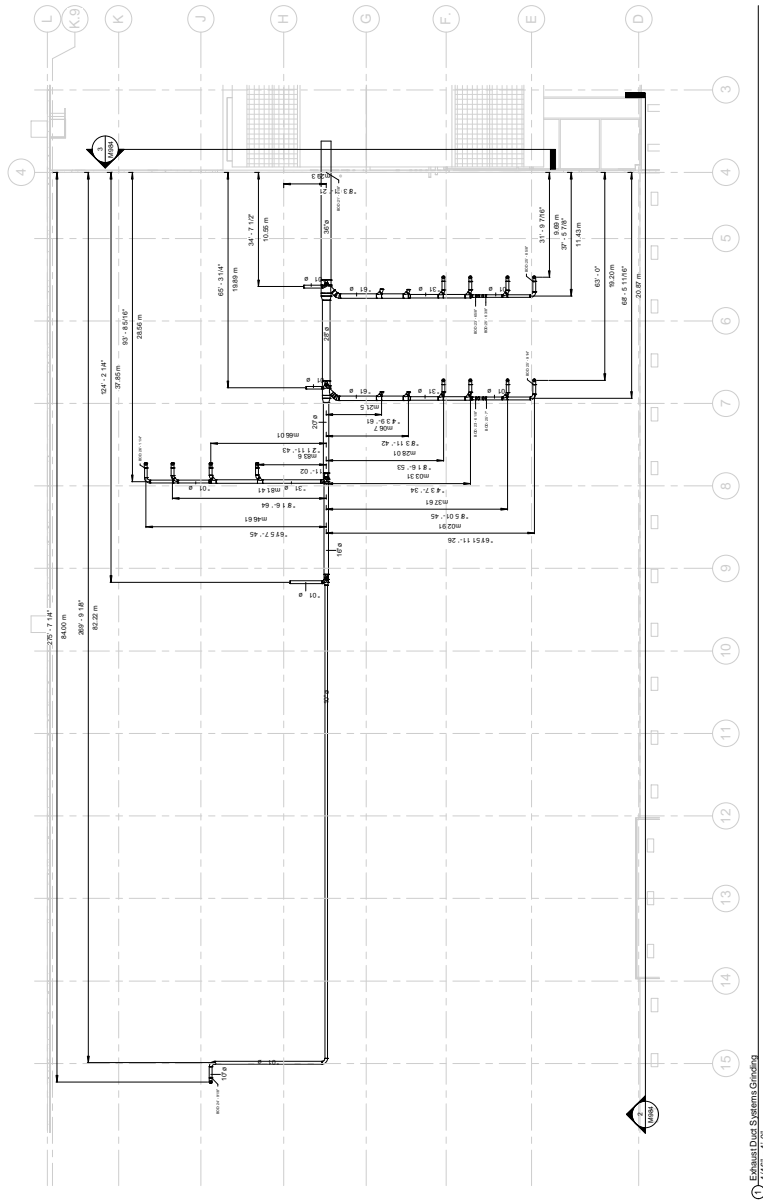

① Exhaust Dust Systems Grinding
 1/16" = 1'-0"

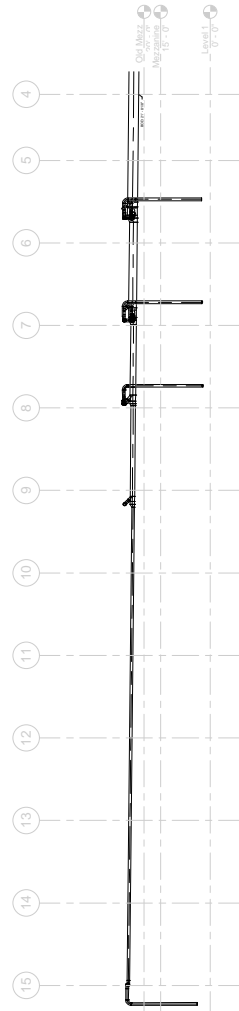

② Exhaust Dust Grinding Section 1
 1/16" = 1'-0"

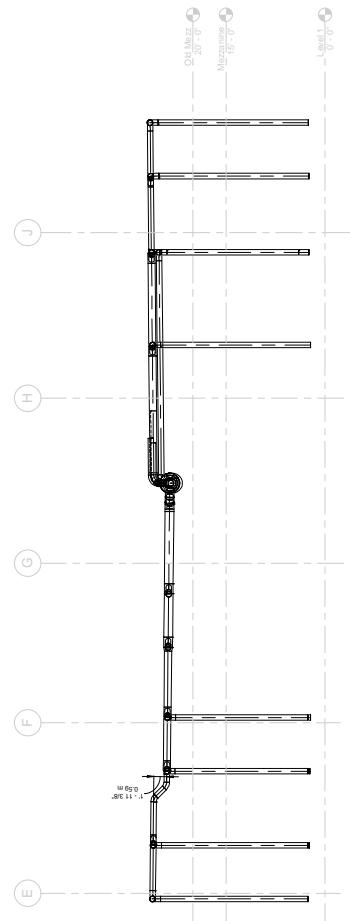

③ Exhaust Dust Grinding Section 2
 1/8" = 1'-0"