



**Date:** September 01, 2011

**To:** MSI

**Project:**

**Attn:** Mr. William F. Bailey

**Recommended Equipment:**

(3) pcs SDT-180 to be (1) set: table top with rubber rings

- gap between table joints
- table outlet: 6.8" OD

(1) SDC-15-16 Cartridge Collector Drum Type

- 6,400 CFM @ 8" SP
- normal 52"L polyester cartridges
- inlet: dia. 16" (angle flange)
- explosion vent: 24"W x 36"H x 2pcs

---

**Avani Environmental Inc.**  
95 Cypress Drive  
Youngsville, NC 27596  
[www.avanienvironmental.com](http://www.avanienvironmental.com)

Phone: (919) 570-2862  
Fax: (919) 570-2863  
Email: [info@avanienvironmental.com](mailto:info@avanienvironmental.com)  
[www.weldingbooths.com](http://www.weldingbooths.com)

DO NOT SCALE

IF IN DOUBT ASK



Revisions			
Rev	Description	Date	Approved

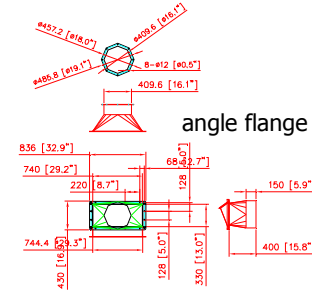
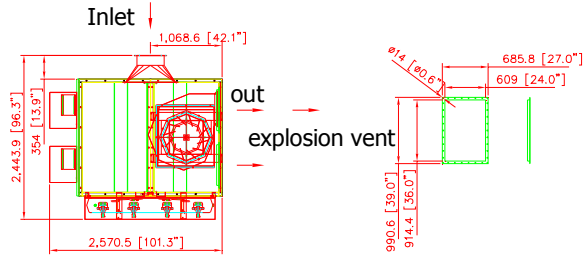

- SDC-15-16 SPECIFICATION -

- Direct Drive Blower (on top)
- Motor: 15HP x 1 pc
- CFM: 6,400 ft<sup>3</sup>/min @ 8" SP
- Include:
  - UL Individual Control Boxes for Cartridge Collector and Blowers
- \*\*\*Inlet: Dia. 16" (will provide inlet square to round)
- Cartridge Filter: Dia. 325mm x 1320mm x 16pcs (Dia. 12.8" x 52" x 16pcs)
- Material: Polyester with TEFLON coating.
- Filter Area: 19m<sup>2</sup> x 16 = 304 m<sup>2</sup> (3271.04 ft<sup>2</sup>)
- Pleat Depth: 48mm
- Horizontal Positioned Filters,
- Continuous Welded Seams,
- Gasket and Latched Doors,
- Powder Coated Paint and
- Reverse Jet Pulse Cleaning
- Include:
  - Drum & Jack Lifting Tool
  - Filter Chamber
  - Hopper
  - Inlet Square Pipe (need dimensions)
  - Fan/motor combinations
- No. of Valves: 4
- Inlet Air: 4"
- Compressed Air Requirement: 90 PSI
- Compressed Air Reservoir: 15.8 gallon
- Dimension: 88.4" x 96.1" x 216.5" (2244 x 2440.1 x 5495mm)
- Construction: 13 Gauge for panel; 11 Gauge Steel Cabinet
- Max. Operating Temp.: 120°C
- Paint Color: Blue

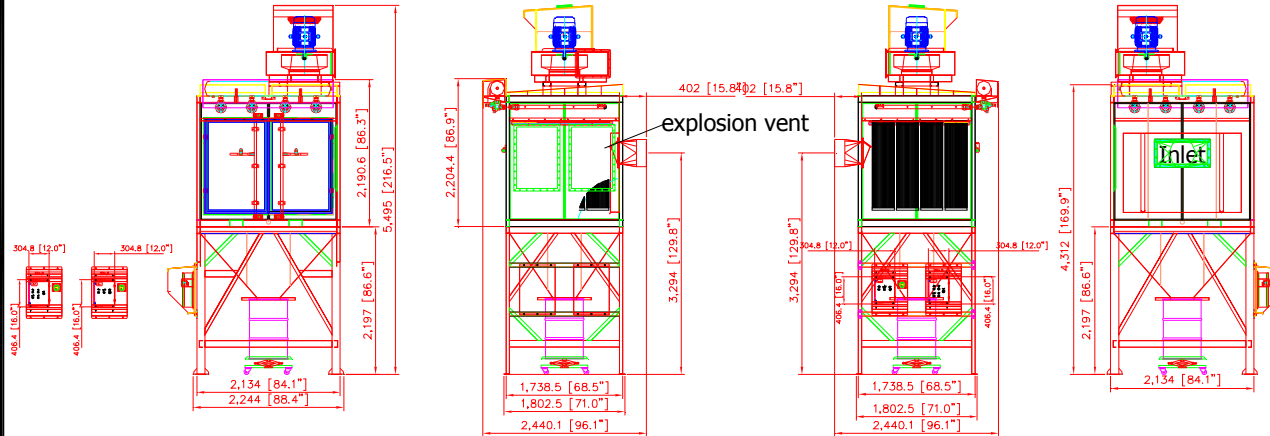

pulse control box on the left  
blower control box on the left

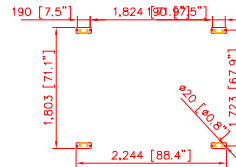

PLAN DETAIL

\*\*\*hole for explosion vent: 24"W x 36"H x 2pcs  
\*\*\*pulse control box run off of 120V, 1-phase, no transformer inside pulse box.

AVANI ENVIRONMENTAL INTL. INC. Sales Department 95 Cypress Drive Youngsville, NC 27596 info@avanienvironmental.com	Date 2011-09-01	Name ***	Part Number: SDC-15-16	Title: Large Cartridge Collector	
	Drawn by: 2011-08-31	Checked by: 2011-08-31		Size D	Scale 1 = 1
The drawings, AutoCAD, 3-D Models, and specifications are the property of Avani Environmental Intl. Inc. (AE) and may not be reproduced, distributed, modified, or otherwise used, except provided herein, without the express written permission of AE.					

DO NOT SCALE

IF IN DOUBT ASK

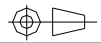

Revisions			
Rev	Description	Date	Approved

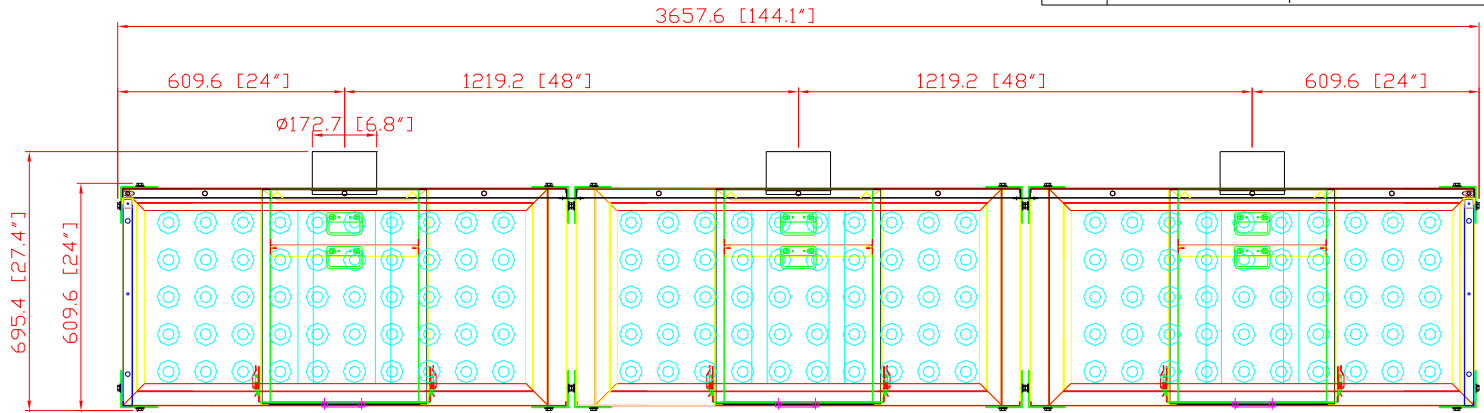

rubber table top

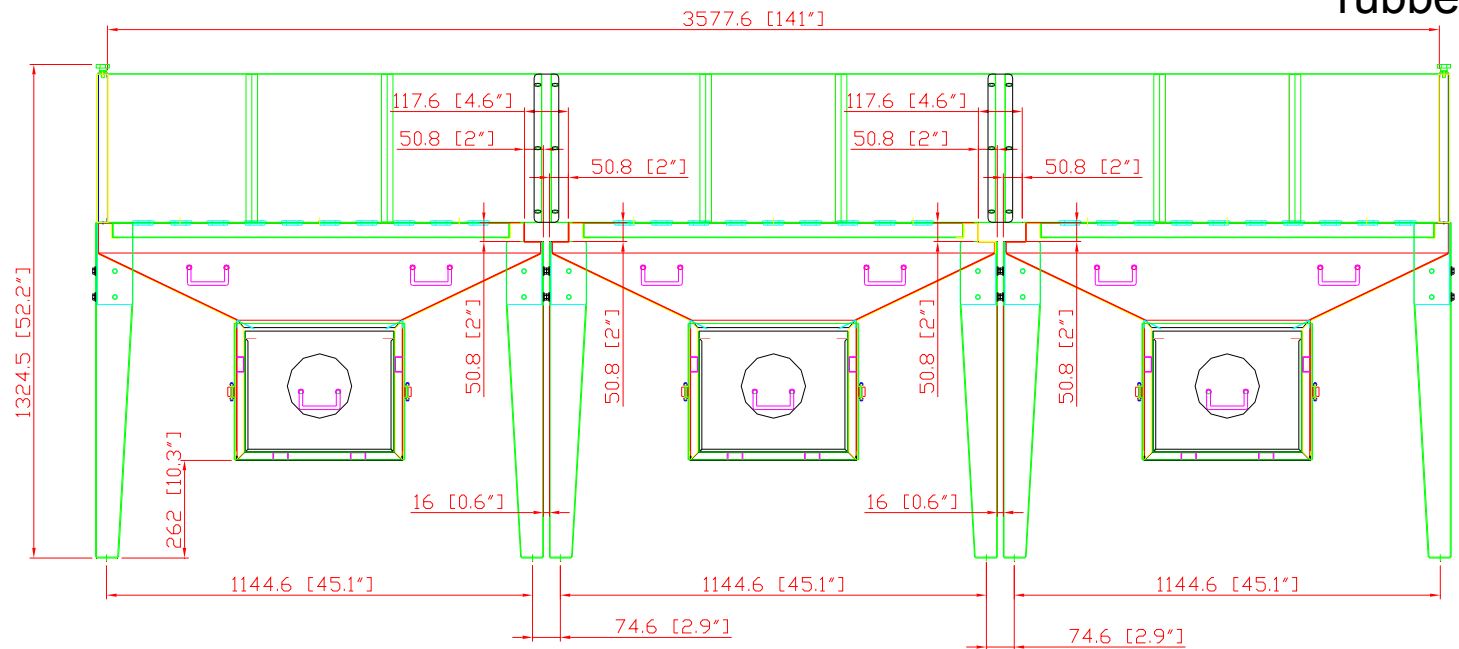

(3) tables to be (1) set

AVANI ENVIRONMENTAL INTL. INC. Sales Department  
 95 Cypress Drive (919) 570-2862  
 Youngsville, NC 27596 info@avanienvironmental.com

Date	Name	Part Number:	Title:
2011-09-01	***	**	(3) SDT-180
Drawn by:	Checked by:	The drawings, AutoCAD, 3-D Models, and specifications are the property of Avani Environmental Intl. Inc. (AE) and may not be reproduced, distributed, modified, or otherwise used, except provided herein, without the express written permission of AE.	

Size	Scale	Drawing Number:
D	1 = 18	solid back joint

DO NOT SCALE

IF IN DOUBT ASK

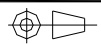

Revisions

Rev	Description	Date	Approved
-----	-------------	------	----------

# left table

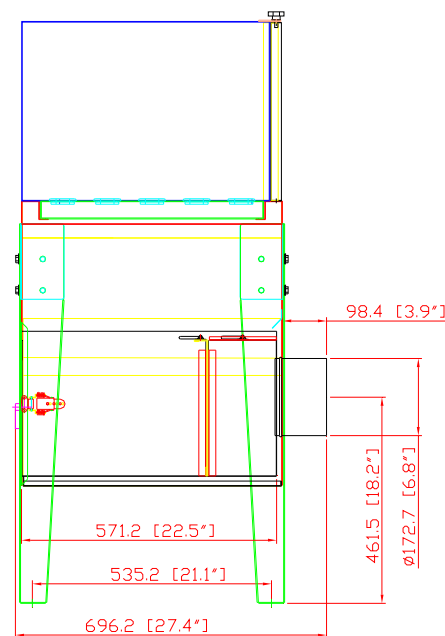
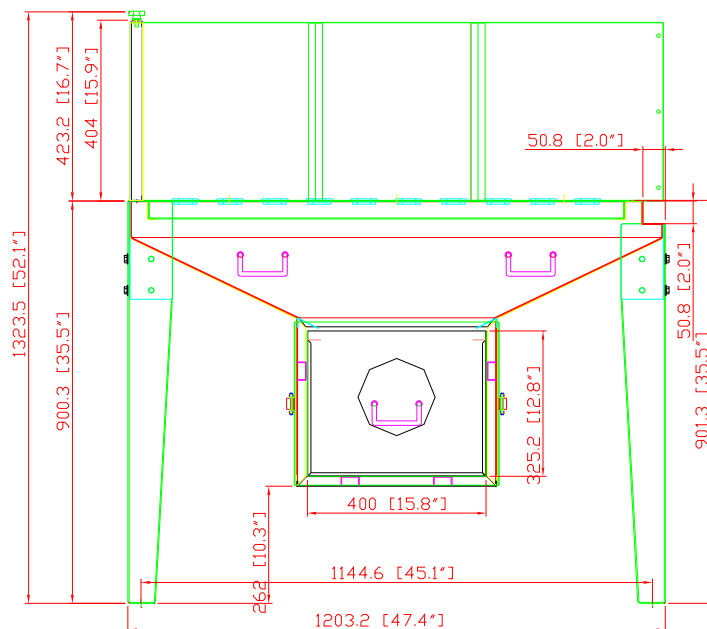
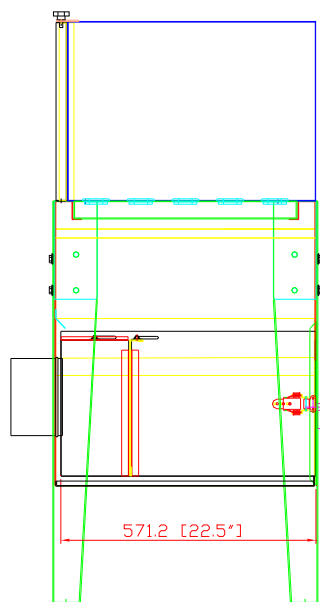
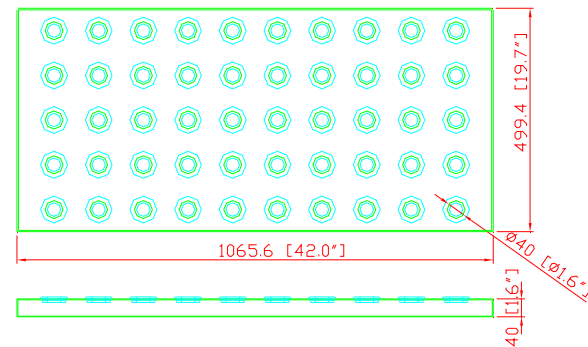
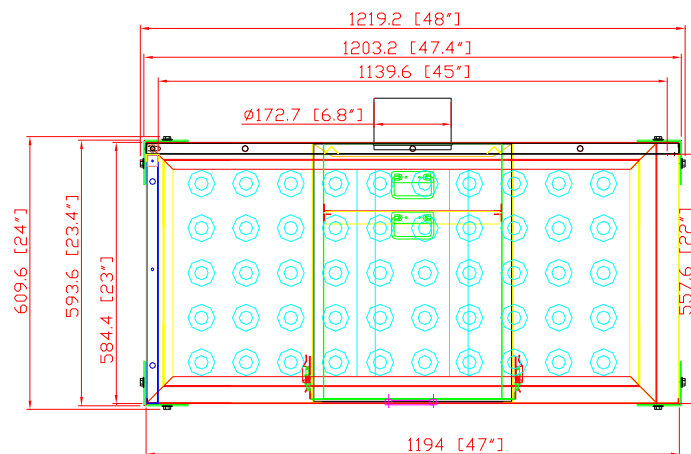

AVANI ENVIRONMENTAL INTL. INC. Sales Department

95 Cypress Drive  
Youngsville, NC 27596

(919) 570-2862  
info@avanienvironmental.com

Date	Name	Part Number:
2011-09-01	***	**
Drawn by:	Checked by:	

The drawings, AutoCAD, 3-D Models, and specifications are the property of Avani Environmental Intl. Inc. (AE) and may not be reproduced, distributed, modified, or otherwise used, except provided herein, without the express written permission of AE.

Title:	SDT-180 (left)	
--------	----------------	--

Size	Scale	Drawing Number:
D	1 = 15	solid back joint

DO NOT SCALE

IF IN DOUBT ASK



Revisions

Rev	Description	Date	Approved
-----	-------------	------	----------

# middle table

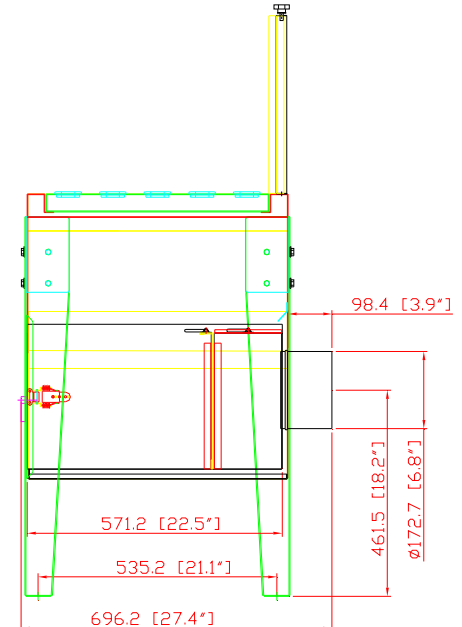
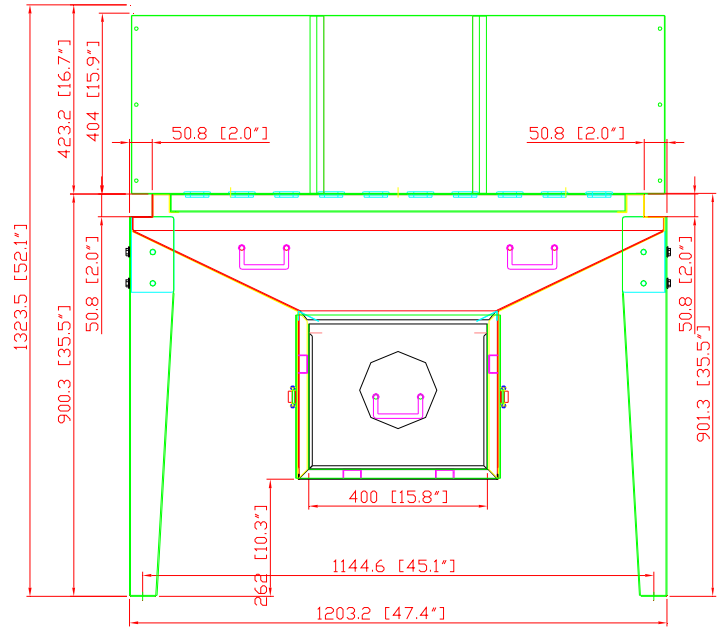
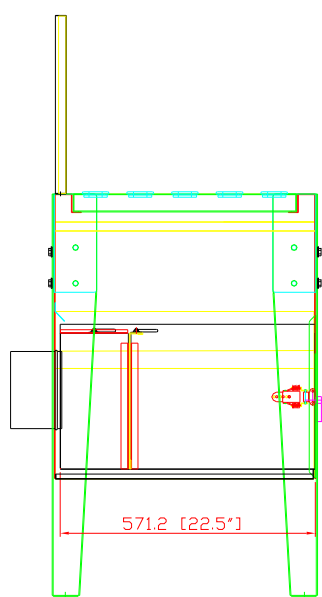
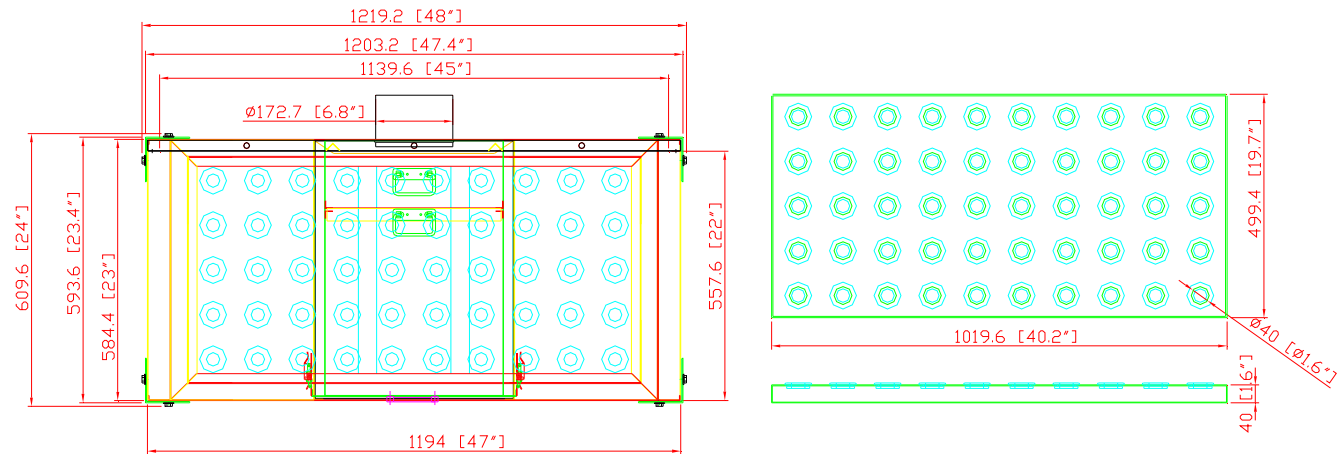

AVANI ENVIRONMENTAL INTL. INC. Sales Department

95 Cypress Drive

Youngsville, NC 27596

(919) 570-2862

info@avanienvironmental.com

Date	Name	Part Number:
2011-09-01	***	**
Drawn by:	Checked by:	

The drawings, AutoCAD, 3-D Models, and specifications are the property of Avani Environmental Intl. Inc. (AE) and may not be reproduced, distributed, modified, or otherwise used, except provided herein, without the express written permission of AE.

Title:	SDT-180 (middle)	
--------	------------------	--

Size	Scale	Drawing Number:
D	1 = 15	solid back joint

DO NOT SCALE

IF IN DOUBT ASK

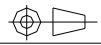

Revisions

Rev	Description	Date	Approved
-----	-------------	------	----------

right table

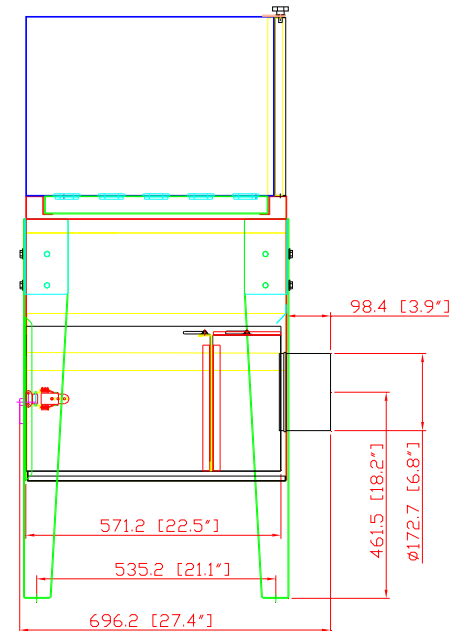
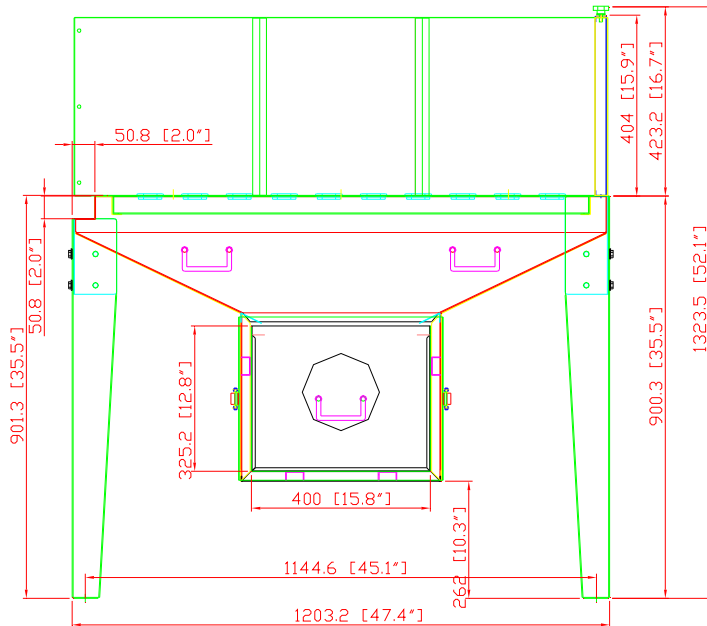
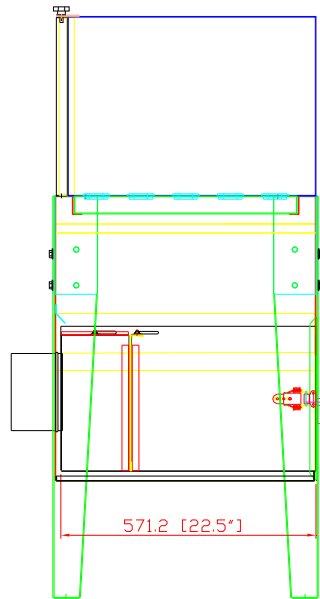
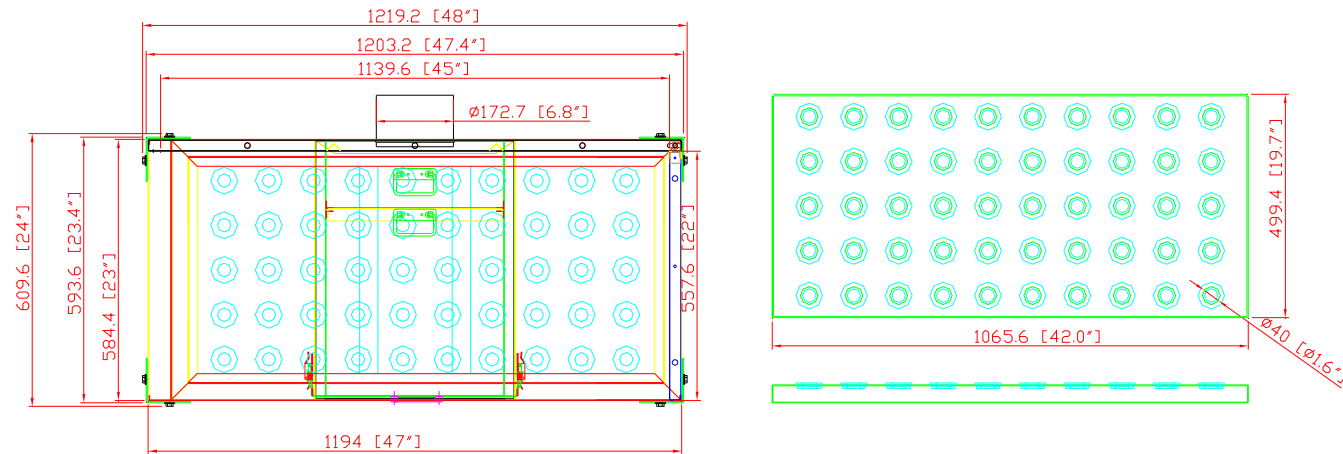

AVANI ENVIRONMENTAL INTL. INC. Sales Department  
 95 Cypress Drive  
 Youngville, NC 27596

(919) 570-2862  
 info@avanienvironmental.com

Date	Name	Part Number:
2011-09-01	***	**
Drawn by:	Checked by:	

The drawings, AutoCAD, 3-D Models, and specifications are the property of Avani Environmental Intl. Inc. (AE) and may not be reproduced, distributed, modified, or otherwise used, except provided herein, without the express written permission of AE.

Title: SDT-180 (right)

Size	Scale	Drawing Number:
D	1 = 15	solid back joint