

DO NOT SCALE

IF IN DOUBT ASK

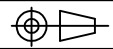

Revisions			
Rev	Description	Date	Approved

- SDC-15-16 SPECIFICATION -

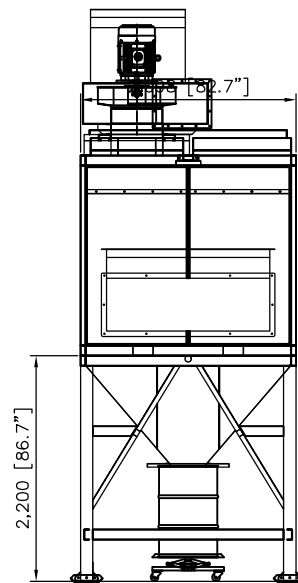
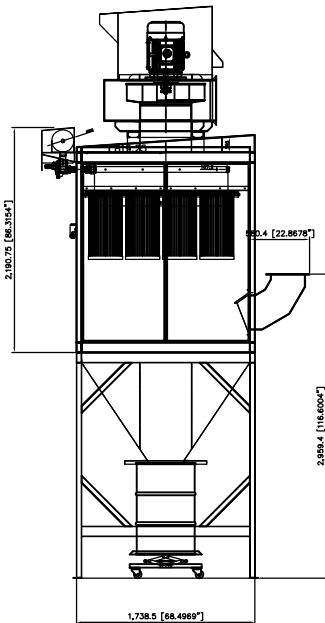
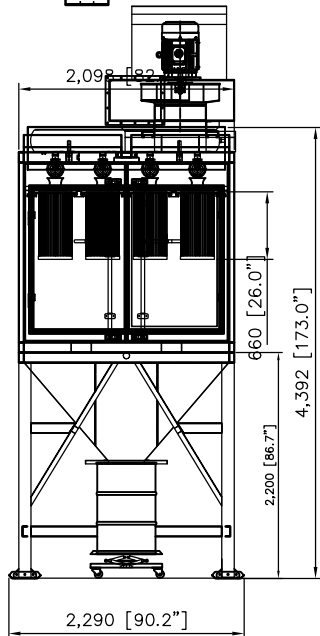
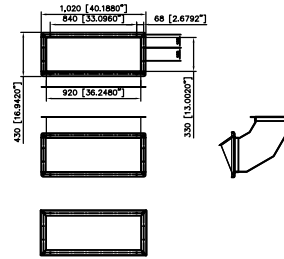
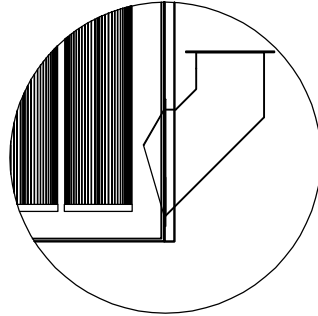
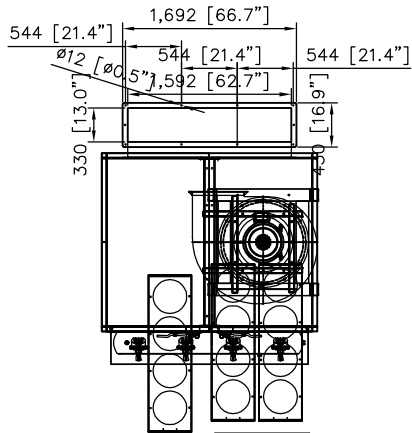

- Direct Drive Blower (on top)
- Motor: 15HP x 1 pc
- CFM: 6000 ft³/min @ 8" SP
- Include:
 - UL Individual Control Boxes for Cartridge Collector and Blowers
- Inlet: 920 x 330 mm (36.2" x 13")
- *** Cartridge Filter: Dia. 325mm x 660mm x 16pcs (Dia. 12.8" x 26" x 16pcs)
- *** Material: 80/20 Fr.
- 80/20 Filter Area: 20m² x 16 = 320m² (3443.2 ft²)
- Pleat Depth: 48mm
- Horizontal Positioned Filters,
- Continuous Welded Seams,
- Gasket and Latched Doors,
- Powder Coated Paint and
- Reverse Jet Pulse Cleaning
- Include:
 - Drum & Jack Lifting Tool
 - Filter Chamber
 - Hopper
 - Inlet Square Pipe (need dimensions)
- No. of Valves: 4
- Inlet Air: $\frac{3}{4}$ "
- Compressed Air Requirement: 90 PSI
- Compressed Air Reservoir: 15.8 gallon
- Dimension: 90.2" x 68.5" x 173" (2290 x 1738.5 x 4392mm)
- Construction: 13 Gauge for panel; 11 Gauge Steel Cabinet
- Max. Operating Temp.: 120°C
- Paint Color: Blue

OSKAR ENVIRONMENTAL, INC.
95 Cypress Drive
Youngsville, NC 27596

Sales Department
(919) 570-2862
sales@oskarsales.com

Date	Name	Part Number:	Title:	
2009-09-10	XXXXX	SV-1600-15	SDC-15-16 (80/20 Fr @ 660mmL)	
Checked by:			Size	Scale
This drawing is confidential and is the exclusive property of Oskar Environmental. No unauthorized use/copy or disclosure is to be made and it is returned whenever required.			A	1 = 1
			Drawing Number: SV-1600-15-01	