



+ Installations for WB-6055P + SDC-B-3-2.



✚ Installations for WB-6055P + SDC-B-3-2.

- Take out the number: **BBU . BBL**
- Join **BBU** to **BBL** with:

Hardware G				
Part name	Description	Photos	Q'ty	Grainger Model #
Hex Screw	5/16" X 3/4"		1	1YU33
Flat Washer	5/16" x OD23 x 2T		1	*1JY31

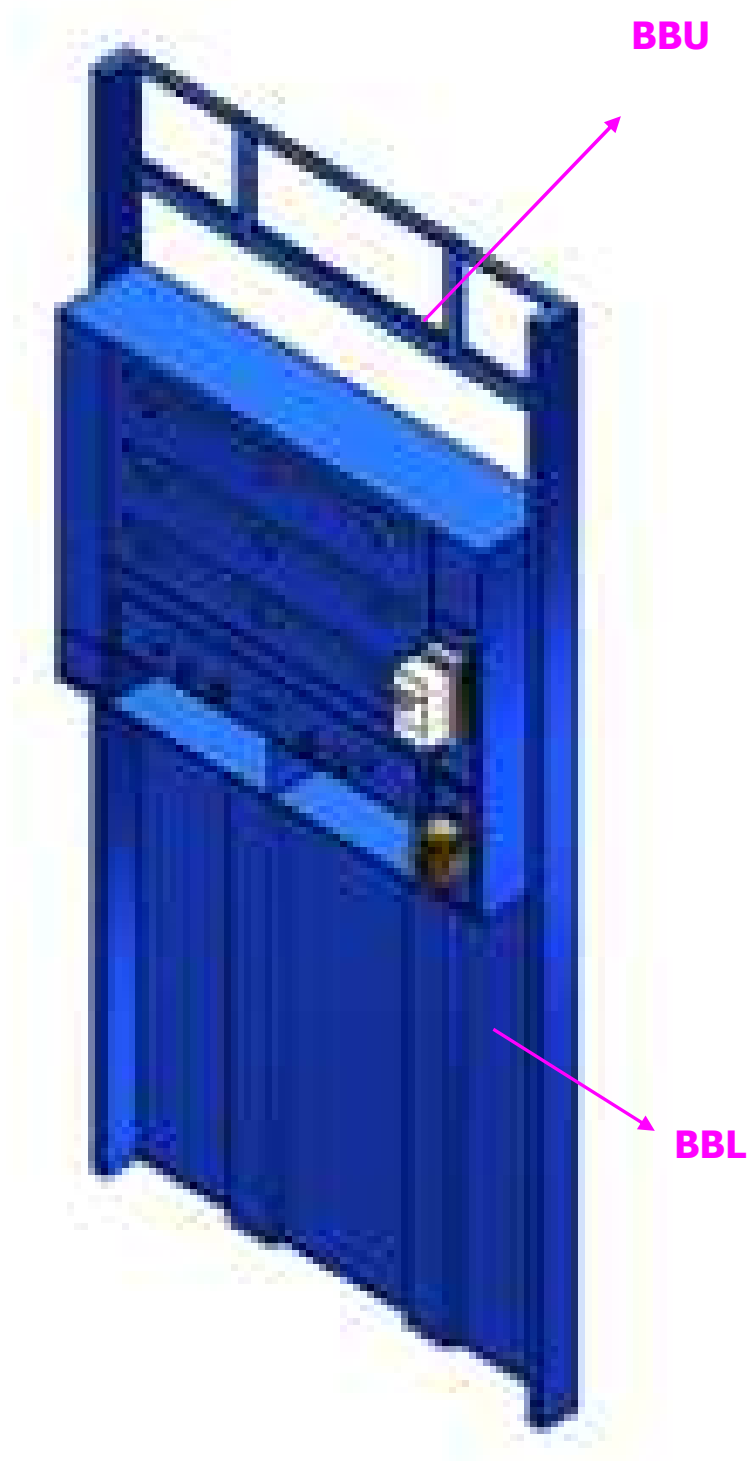

(* Hardware item at similar spec available locally.

✚ Installations for WB-6055P + SDC-B-3-2.

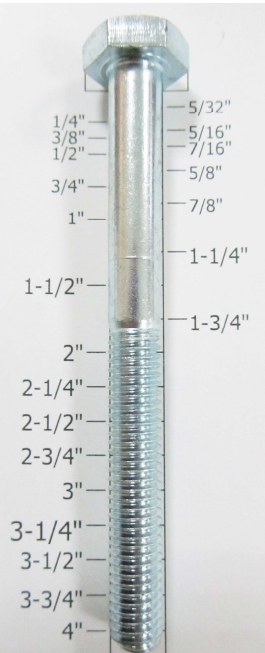

✚ Installations for WB-6055P + SDC-B-3-2.

- Take out the number: **BBU** . **BBL** and **LSD**
- Join **BBU** . **BBL** and **LSD** together with:

Hardware D				
Part name	Description	Photos	Q'ty	Grainger Model #
Half-thread Screw	3/8 x 4"		9	1KA62
Flat Washer	3/8" x OD23 x 2T		18	*1JY33
Nylon Hex Nut	3/8"		9	3HDU4

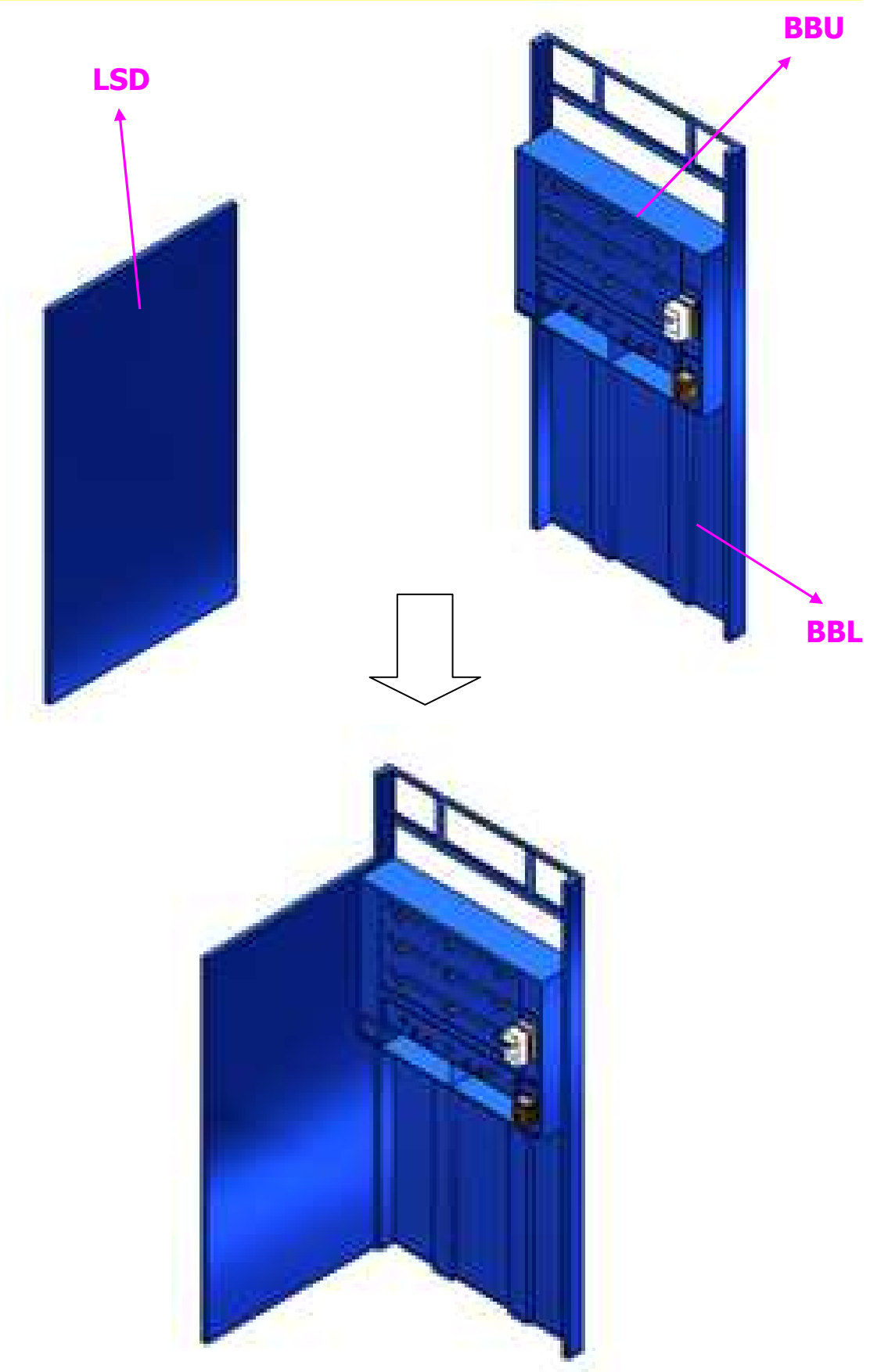

(*) Hardware item at similar spec available locally.

✚ Installations for WB-6055P + SDC-B-3-2.

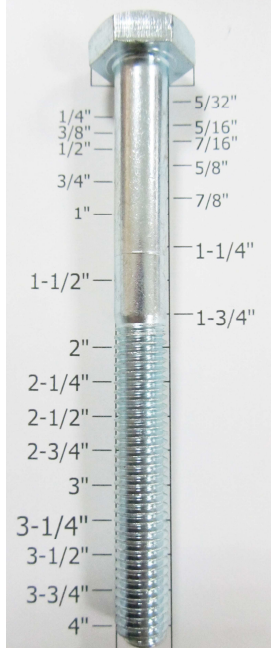

✚ Installations for WB-6055P + SDC-B-3-2.

- Take out the number: **RSD**.
- Fasten **RSD** to **BBU** and **BBL** together with:

Hardware C				
Part name	Description	Photos	Q'ty	Grainger Model #
Hex Screw (Partially Threaded)	3/8 x 4"		8	1KA62
Flat Washer	3/8" x OD23 x 2T		16	*1JY33
Nylon Hex Nut	3/8"		8	3HDU4

(*) Hardware item at similar spec available locally.

Installations for WB-6055P + SDC-B-3-2.

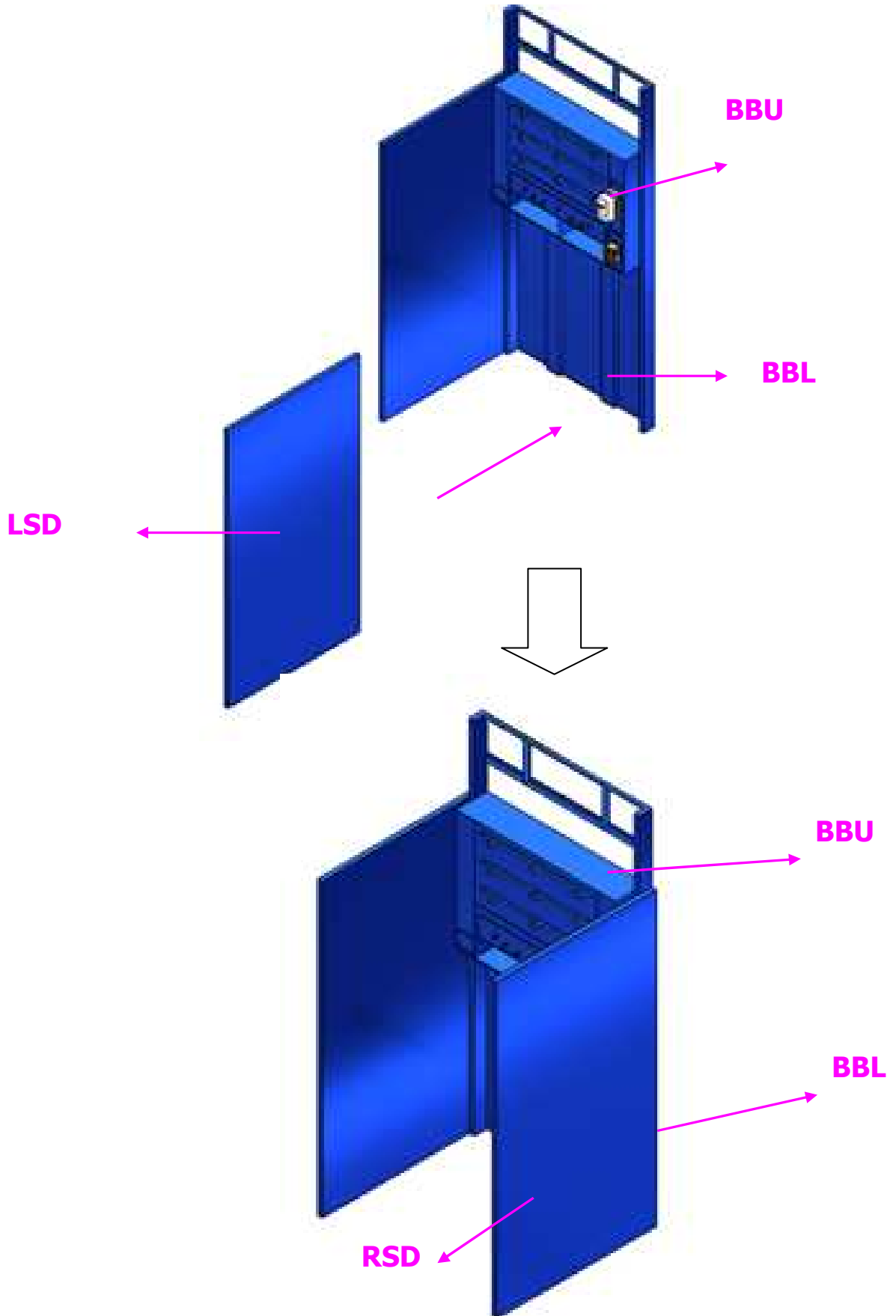

✚ Installations for WB-6055P + SDC-B-3-2.

- Take out the number: **FBL**
- Fasten **FBL** to **BBU** and **LSD** with:

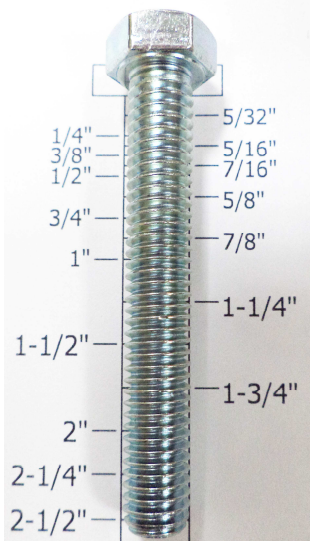
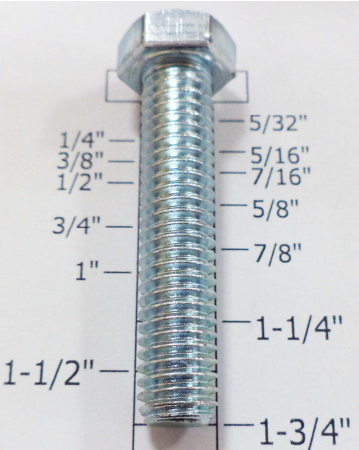
Hardware A				
Part name	Description	Photos	Q'ty	Grainger Model #
Hex Screw	3/8 x 2-1/2"		2	1YU47
Hex Screw	3/8 x 3/4"		1	1YU42

Hex Screw	5/16" X 3/4"		1	1YU33
Nylon Hex Nut	3/8"		2	3HDU4
Flat Washer	3/8" x OD23 x 2T		5	*1JY33
Flat Washer	5/16" x OD23 x 2T		1	*1JY31

(* Hardware item at similar spec available locally.

Installations for WB-6055P + SDC-B-3-2.

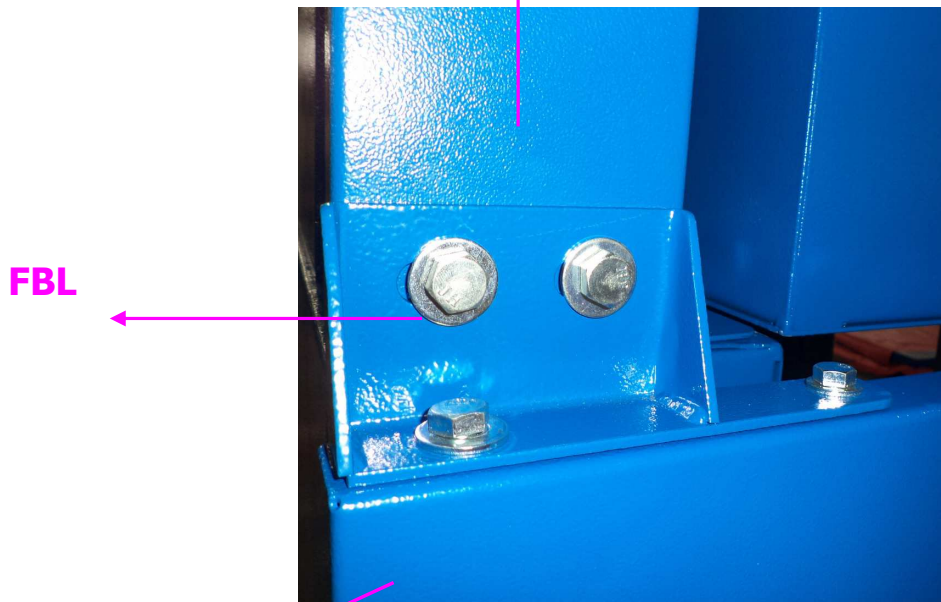
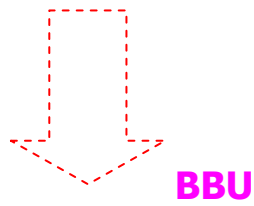
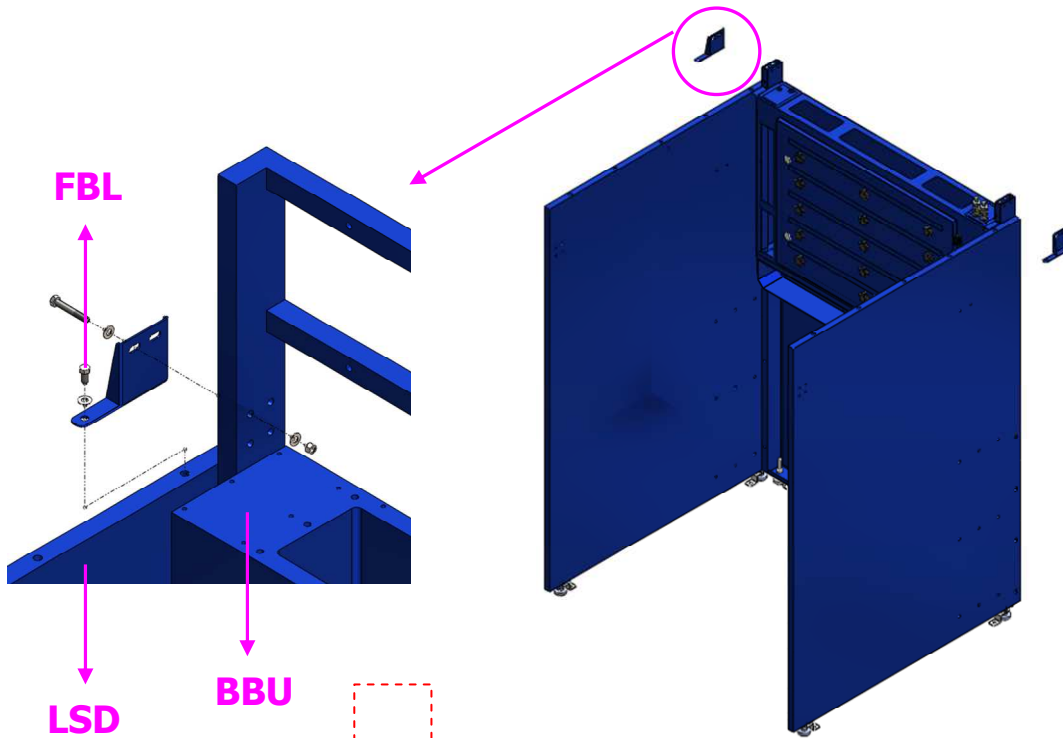

RSD

✚ Installations for 6055P + SDC-B-3-2.

- Take out the number: **FBR**
- Fasten **FBL** to **BBU** and **RSD** with:

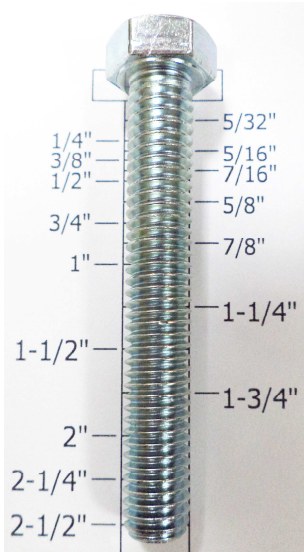
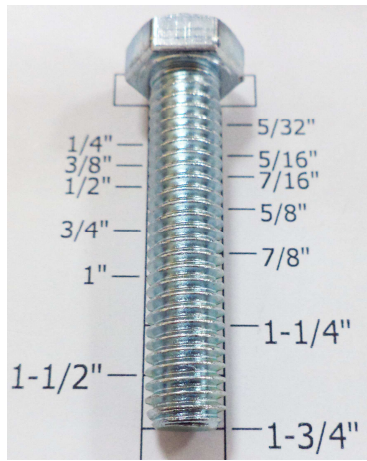
Hardware B				
Part name	Description	Photos	Q'ty	Grainger Model #
Hex Screw	3/8 x 2-1/2"		2	1YU47
Hex Screw	3/8 x 3/4"		1	1YU42

Hex Screw	5/16" X 3/4"		1	1YU33
Nylon Hex Nut	3/8"		2	3HDU4
Flat Washer	3/8" x OD23 x 2T		5	*1JY33
Flat Washer	5/16" x OD23 x 2T		1	*1JY31

(*) Hardware item at similar spec available locally.

Installations for WB-6055P + SDC-B-3-2.

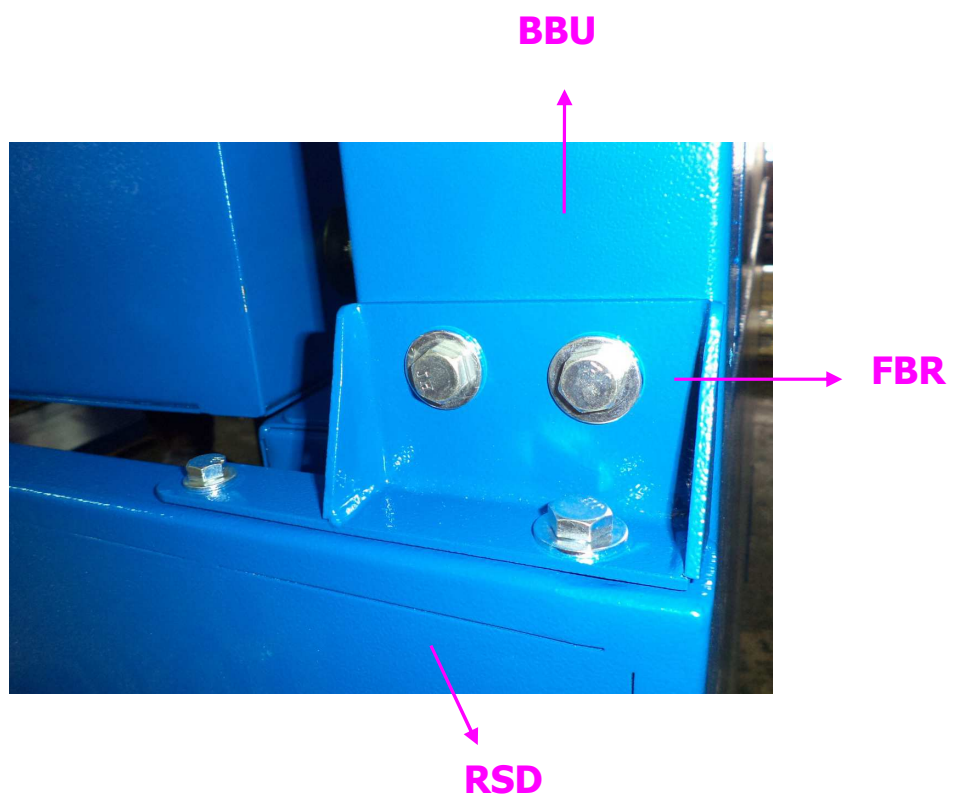
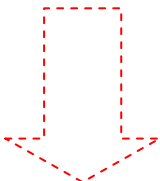
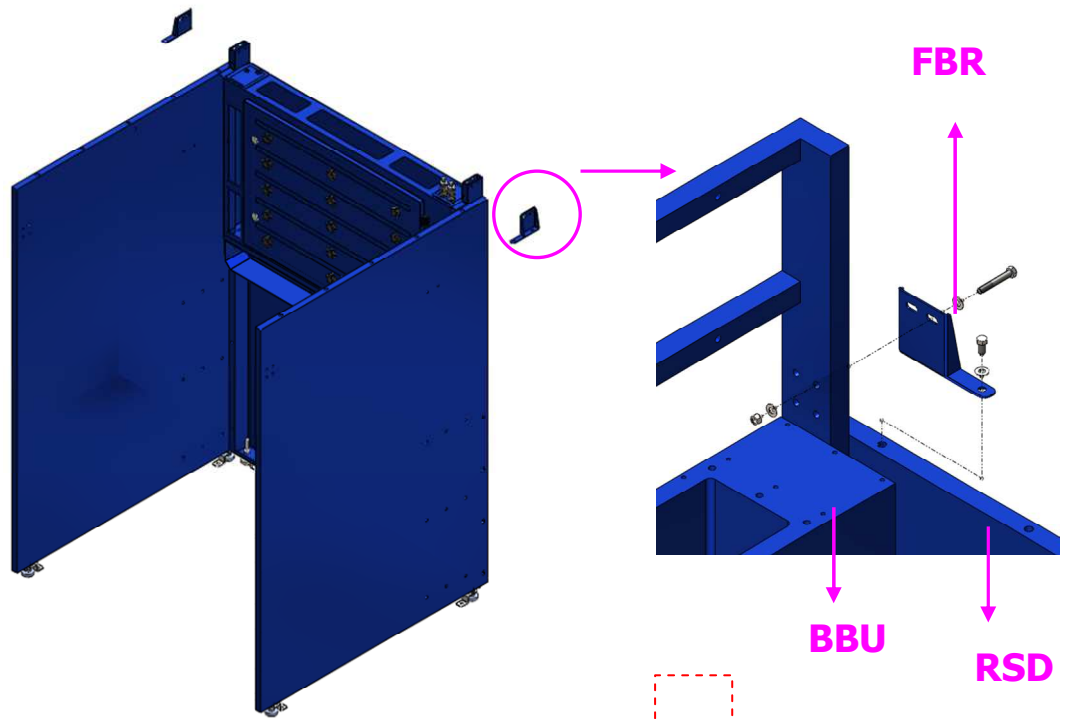

✚ Installations for WB-6055P + SDC-B-3-2.

- Take out the number: **TAB**
- Join **TAB** to **LSD . RSD and BBL** with:

Hardware F				
Part name	Description	Photos	Q'ty	Grainger Model #
Hex Screw	5/16 x 3/4"		8	1YU33
Flat Washer	5/16" x OD18 x 2T		8	*1JY31

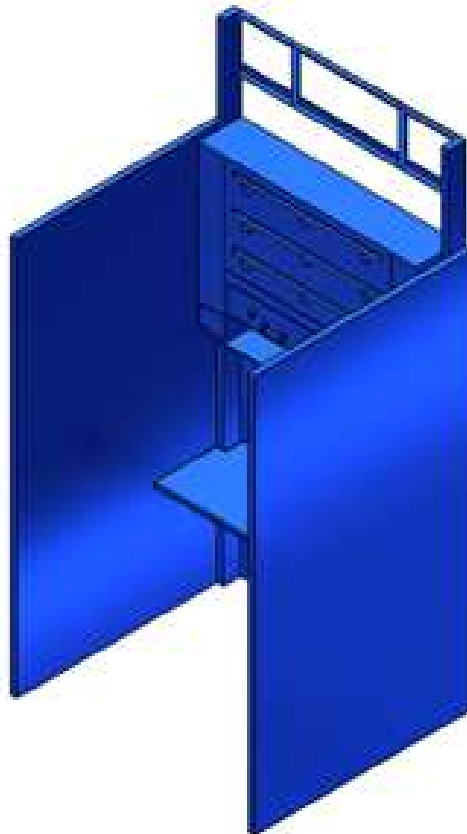
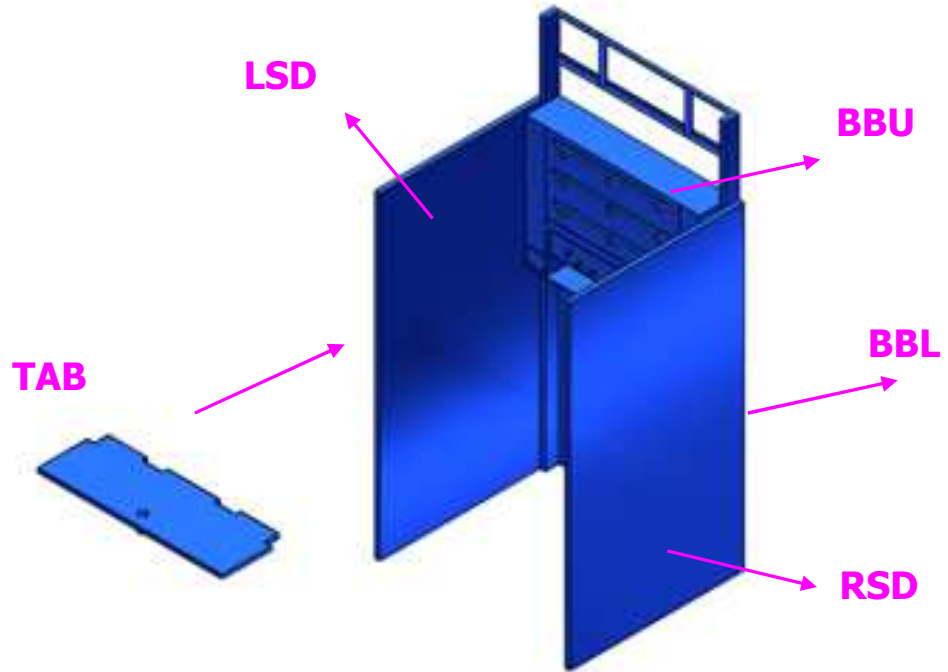

(* Hardware item at similar spec available locally.

✚ Installations for WB-6055P + SDC-B-3-2.

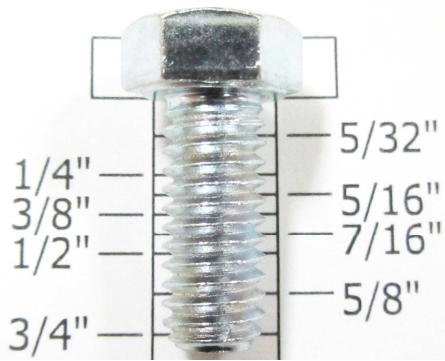

✚ Installations for WB-6055P + SDC-B-3-2.

- Take out the number: **USD**
- Fasten **USD** to **LSD** and **RSD** with:

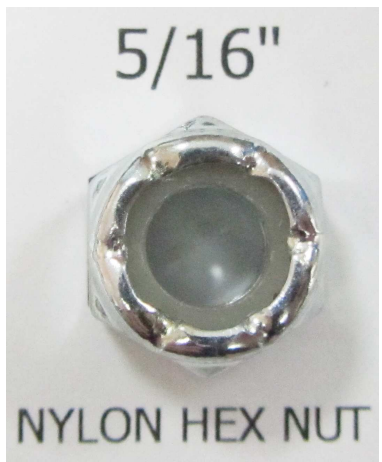
Hardware Q				
Part name	Description	Photos	Q'ty	Grainger Model #
Hex Screw	5/16 x 3/4"		18	1YU33
Flat Washer	5/16" x OD23 x 2T		32	*1JY31
Nylon Hex Nut	5/16"		14	3XTK3



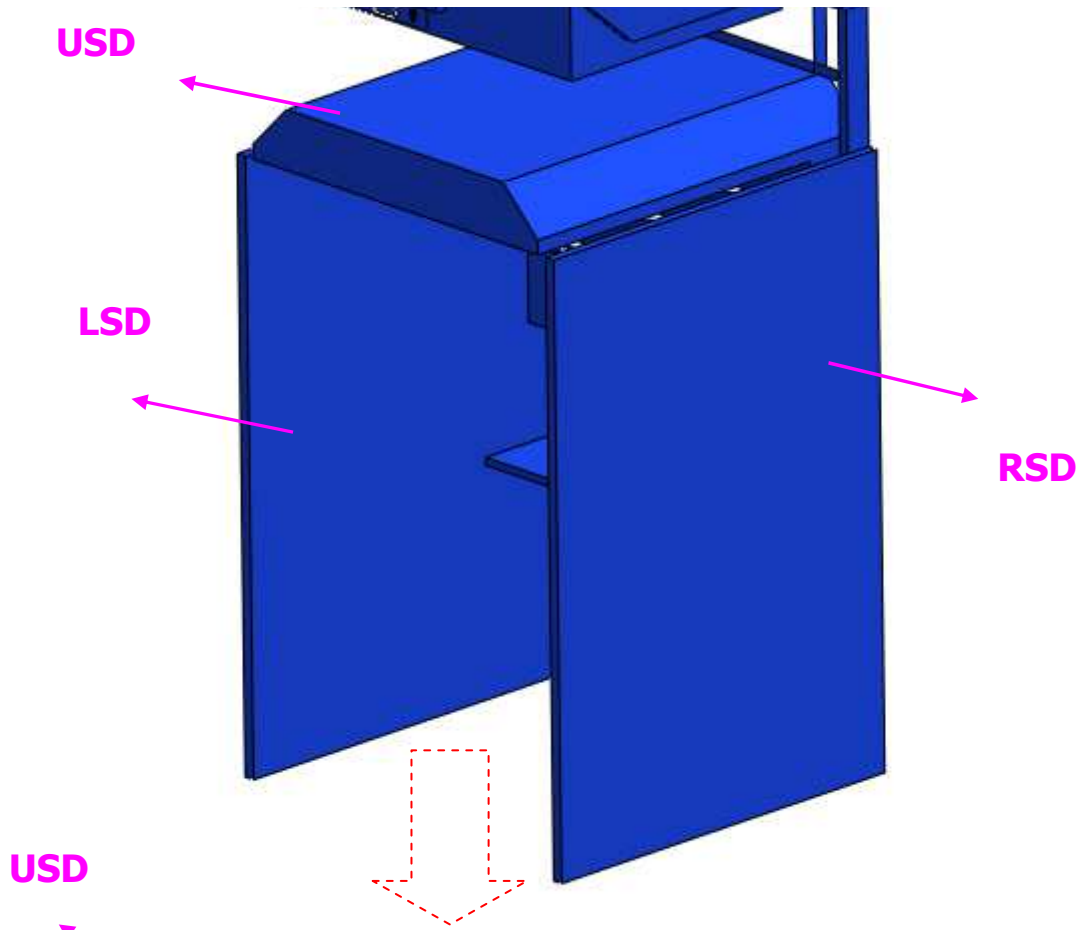

(* Hardware item at similar spec available locally.

✚ Installations for WB-6055P + SDC-B-3-2.



✚ Installations for WB-6055P + SDC-B-3-2.

- Take out the number: **SSPJ. BSPJ**
- Fasten **SSPJ** to **LSD** with:

Hardware P				
Part name	Description	Photos	Q'ty	Grainger Model #
Hex Screw	5/16 x 3/4"		4	1YU33
Flat Washer	5/16" x OD23 x 2T		4	*1JY31
Hex Screw	3/8 x 3/4"		4	1YU42
Flat Washer	3/8" x OD23 x 2T		4	*1JY33

(*) Hardware item at similar spec available locally.

Installations for WB-6055P + SDC-B-3-2.

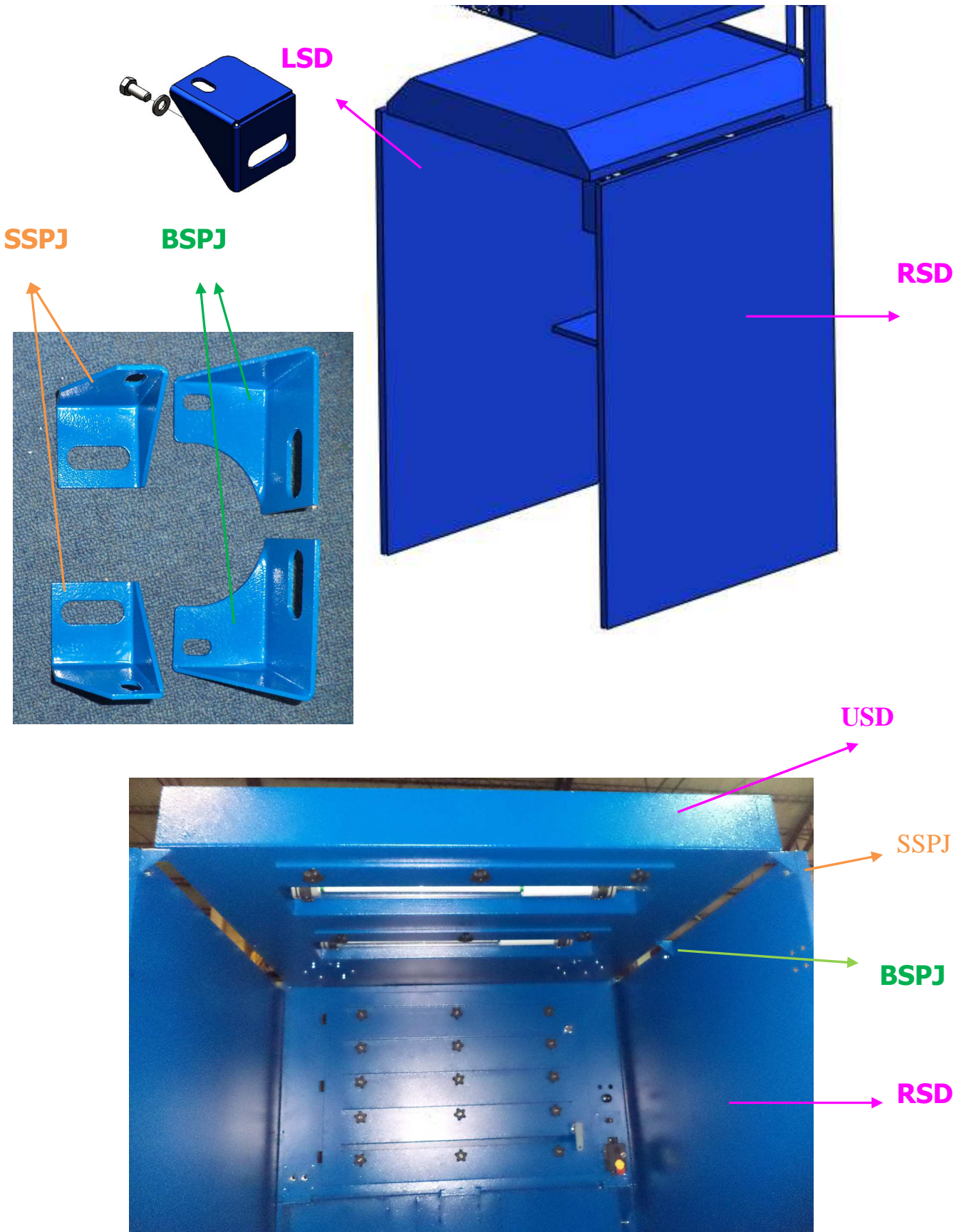

✚ Installations for WB-6055P + SDC-B-3-2.

- Take out the number: **SSPJ. BSPJ**
- Fasten **SSPJ** to **LSD** with:

Hardware O				
Part name	Description	Photos	Q'ty	Grainger Model #
Hex Screw	5/16 x 3/4"		4	1YU33
Flat Washer	5/16" x OD23 x 2T		4	*1JY31
Hex Screw	3/8 x 3/4"		4	1YU42
Flat Washer	3/8" x OD23 x 2T		4	*1JY33

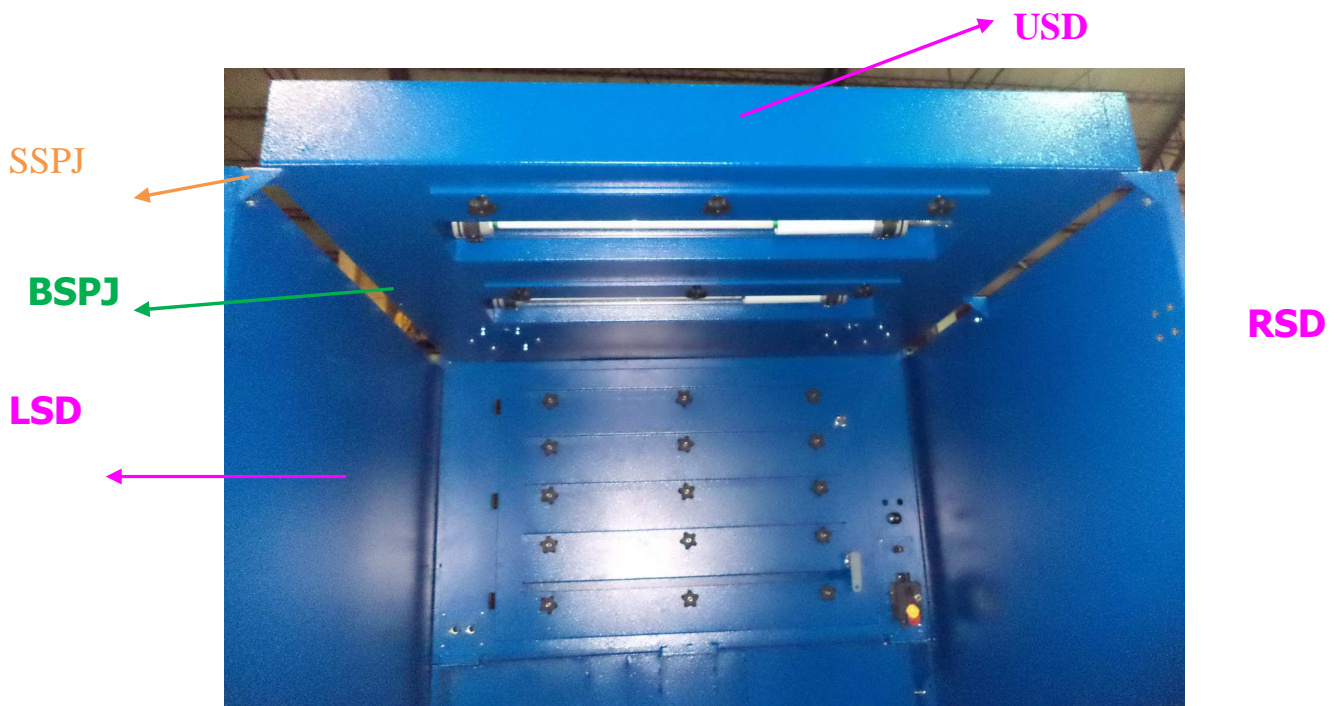
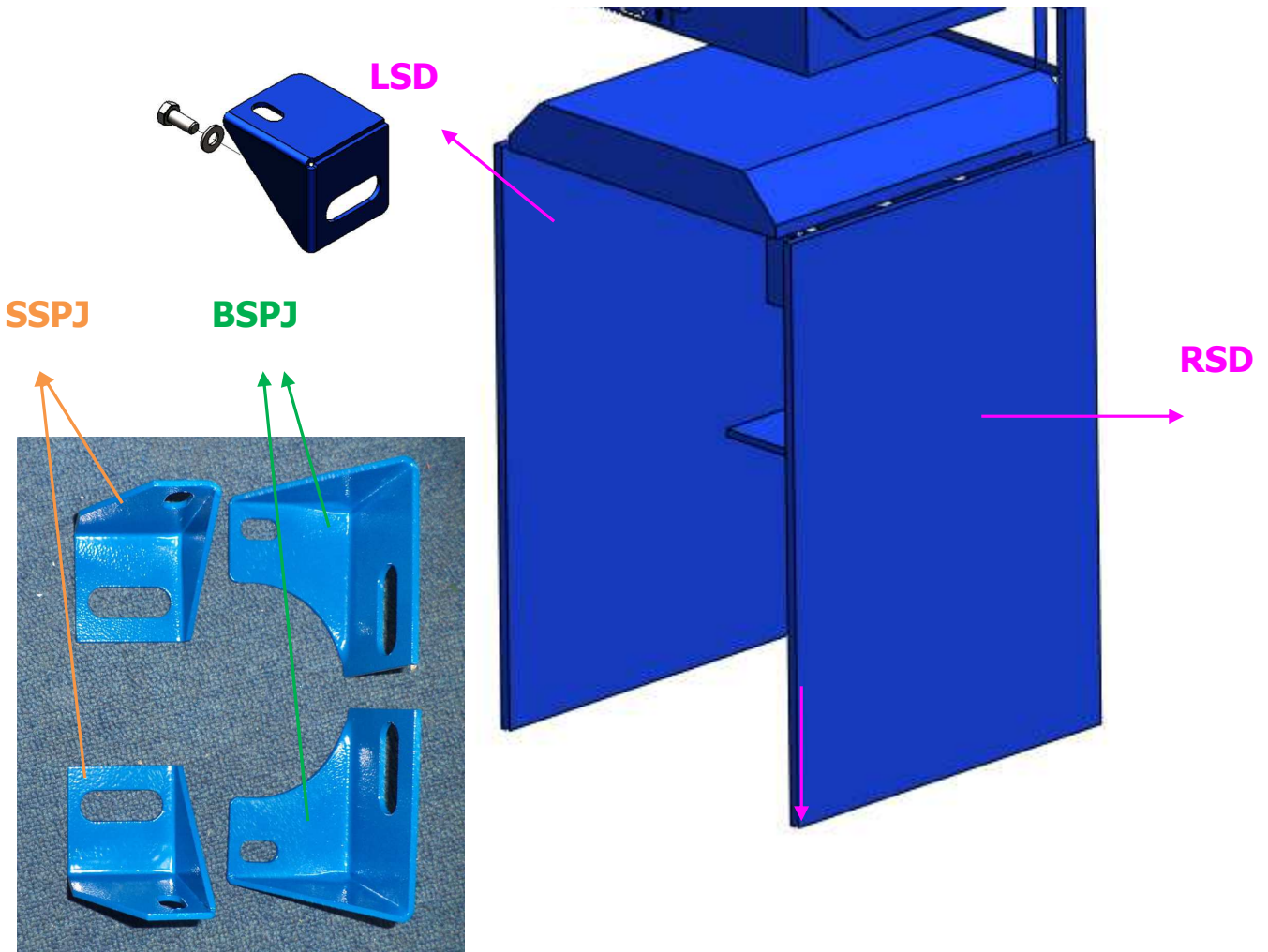

(*) Hardware item at similar spec available locally.

Installations for WB-6055P + SDC-B-3-2.

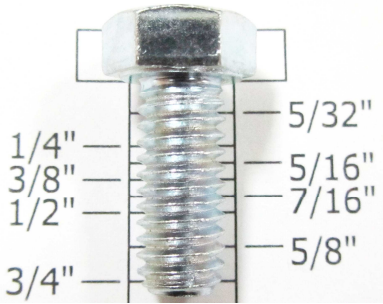

± Installations for WB-6055P + SDC-B-3-2.

- Take out the number: **LUD**
- Fasten **LUD** to **LSD** and **USD** with:

Hardware M				
Part name	Description	Photos	Q'ty	Grainger Model #
Hex Screw	5/16 x 3/4"		9	1YU33
Flat Washer	5/16" x OD23 x 2T		4	*1JY31
Flat Washer	5/16" x OD18 x 2T		5	*1JY31

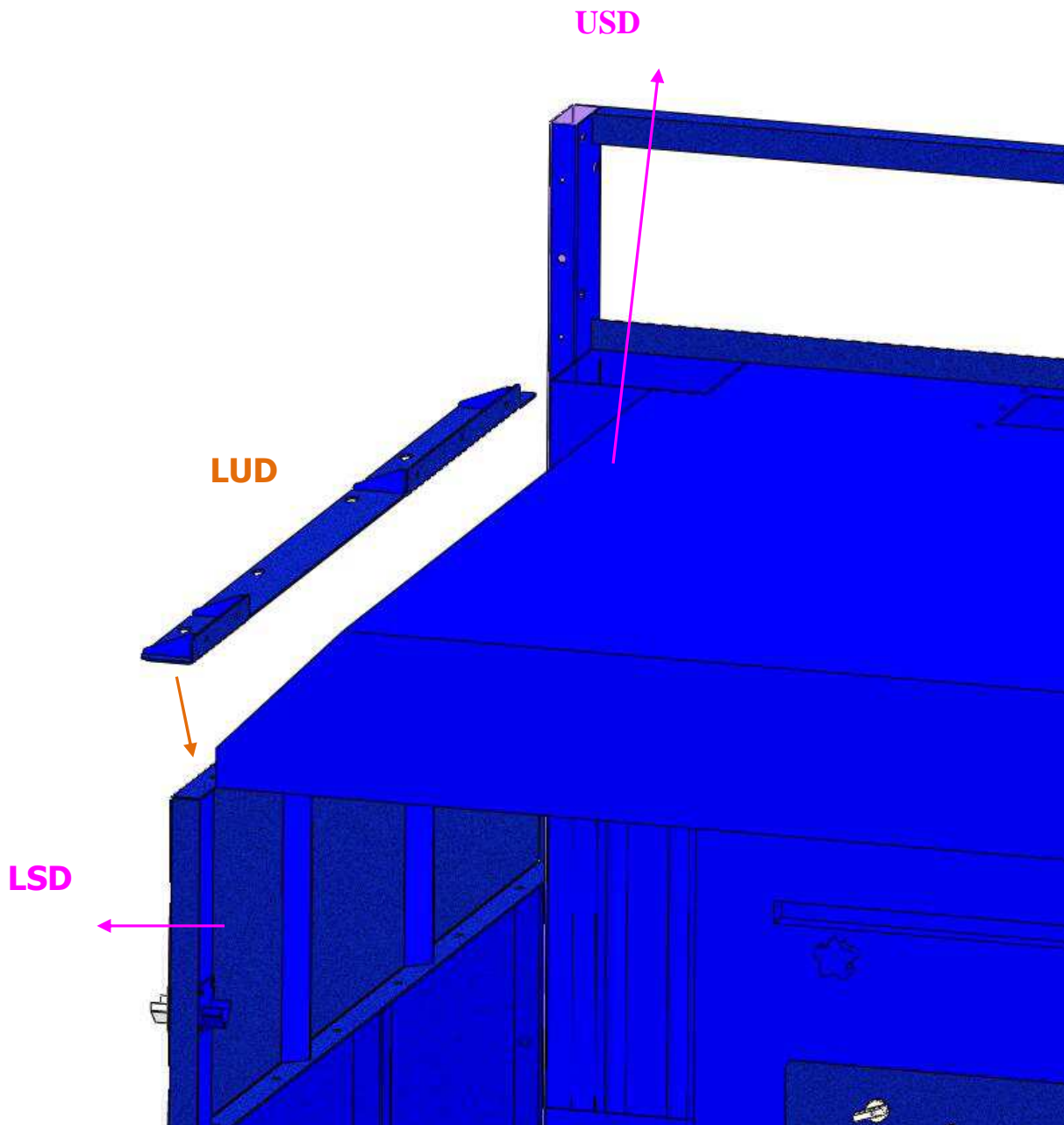

(* Hardware item at similar spec available locally.

Installations for WB-6055P + SDC-B-3-2.

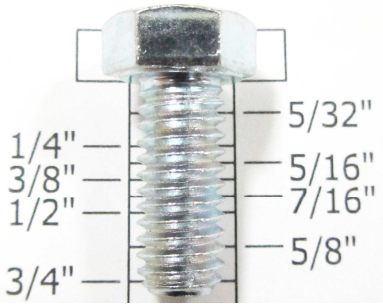

✚ Installations for WB-6055P + SDC-B-3-2.

- Take out the number: **RUD**
- Fasten **RUD** to **RSD** and **USD** with:

Hardware N				
Part name	Description	Photos	Q'ty	Grainger Model #
Hex Screw	5/16 x 3/4"		9	1YU33
Flat Washer	5/16" x OD23 x 2T		4	*1JY31
Flat Washer	5/16" x OD18 x 2T		5	*1JY31

(* Hardware item at similar spec available locally.

✚ Installations for WB-6055P + SDC-B-3-2.

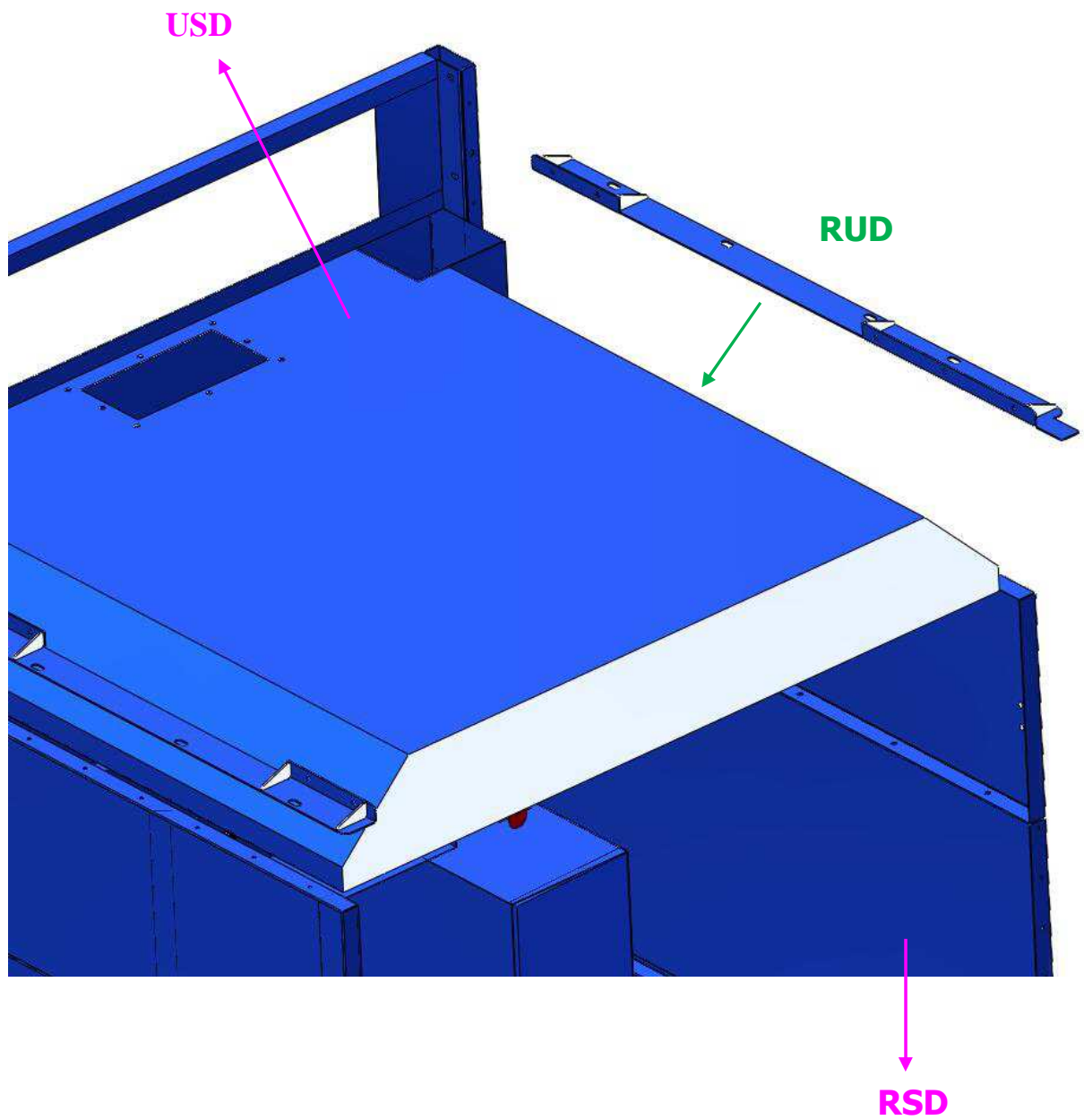

✚ Installations for WB-6055P + SDC-B-3-2.

- Take out the number: **CO2 BRACKET**.
- Fasten **CO2 BRACKET** to **LSD** with:

Hardware E				
Part name	Description	Photos	Q'ty	Grainger Model #
Hex Screw	5/16 x 3/4"		7	1YU33
Flat Washer	5/16" x OD23 x 2T		7	*1JY31

(* Hardware item at similar spec available locally.

✚ Installations for WB-6055P + SDC-B-3-2.

CO2
BRACKET





CO2
BRACKET



LSD

✚ Installations for WB-6055P + SDC-B-3-2.

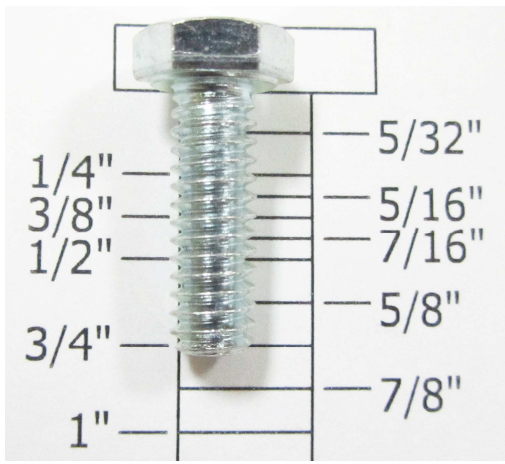
- Take out the number: **CR**.
- Fasten **CR** to **LSD** with:

Hardware I				
Part name	Description	Photos	Q'ty	Grainger Model #
Hex Screw	1/4 x 3/4"		4	1YU24
Flat Washer	1/4" x OD19 x 2T		4	*1JY29

(*) Hardware item at similar spec available locally.

✚ Installations for WB-6055P + SDC-B-3-2.

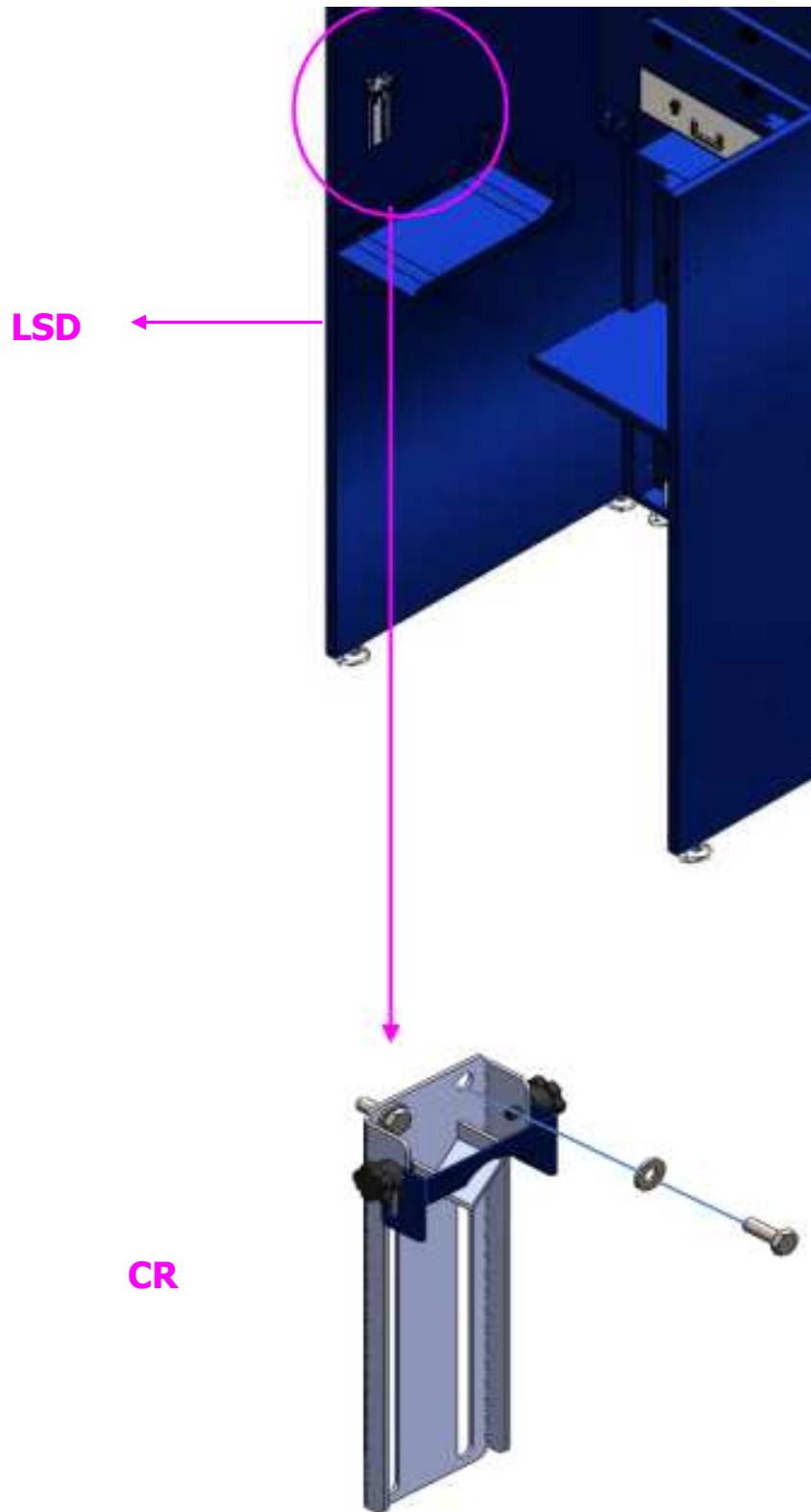

✚ Installations for WB-6055P + SDC-B-3-2.

- Take out the number: **LTB**
- Fasten **LTB** to **USD** with:

Hardware K				
Part name	Description	Photos	Q'ty	Grainger Model #
Hex Screw	5/16 x 3/4"		3	1YU33
Flat Washer	5/16" x OD23 x 2T	<p style="text-align: center;">OD23</p> 	5	*1JY31
Nylon Hex Nut	5/16"	<p style="text-align: center;">5/16"</p>  <p style="text-align: center;">NYLON HEX NUT</p>	2	3XTK3

(*) Hardware item at similar spec available locally.

✚ Installations for WB-6055P + SDC-B-3-2.

- Take out the number: **RTB**
- Fasten **RTB** to **RSD** with:

Hardware L				
Part name	Description	Photos	Q'ty	Grainger Model #
Hex Screw	5/16 x 3/4"		3	1YU33
Flat Washer	5/16" x OD23 x 2T		5	*1JY31
Nylon Hex Nut	5/16"		2	3XTK3

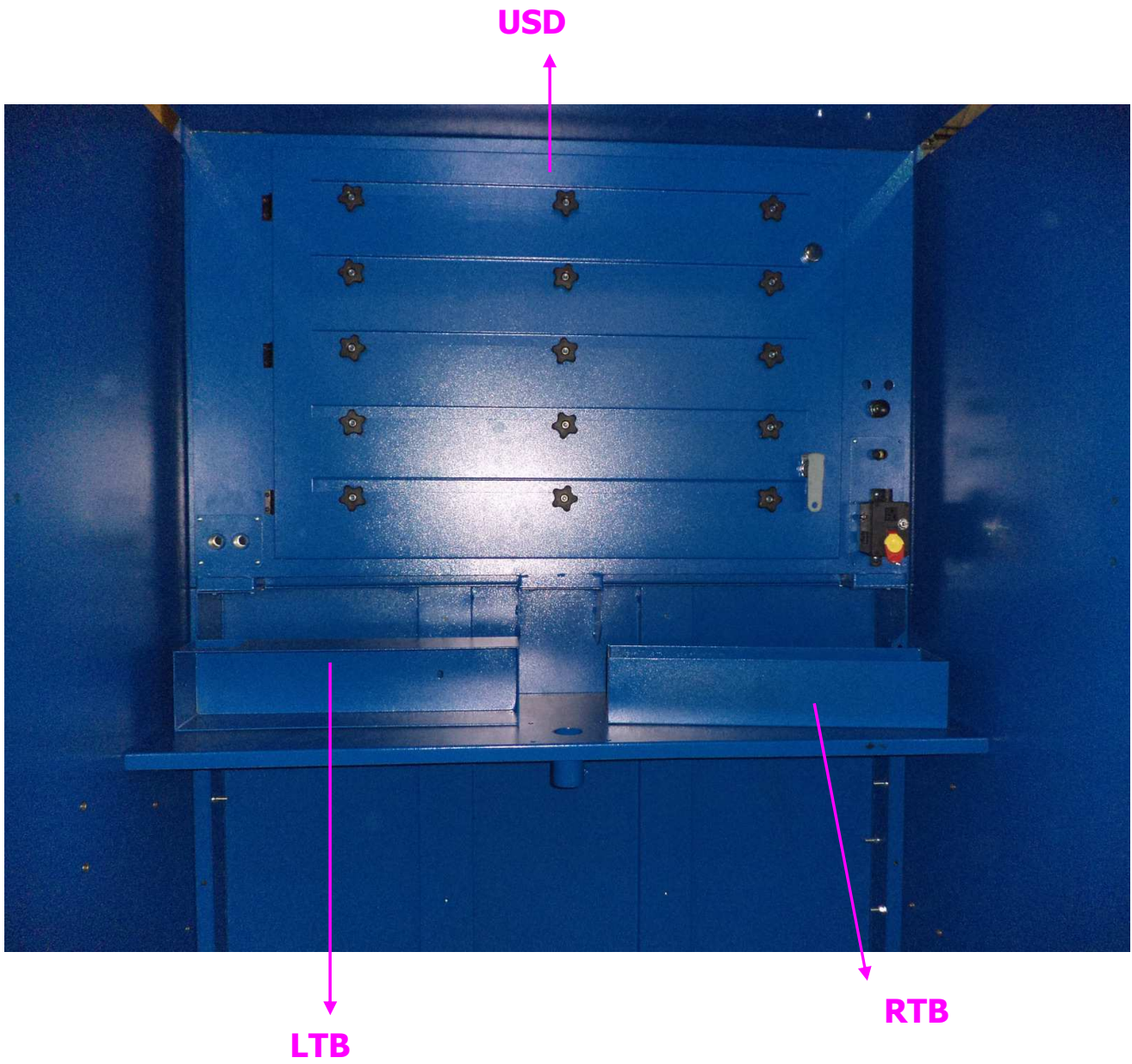

(*) Hardware item at similar spec available locally.

✚ Installations for WB-6055P + SDC-B-3-2.



✚ Installations for WB-6055P + SDC-B-3-2.

- Take out the number: **TMC-3-2**
- Fasten **TMC-3-2** to **USD** with:

Hardware 0				
Part name	Description	Photos	Q'ty	Grainger Model #
Hex Screw	3/8 x 3/4"		10	1YU42
Flat Washer	3/8" x OD23 x 2T		10	*1JY33

(*) Hardware item at similar spec available locally.

✚ Installations for WB-6055P + SDC-B-3-2.

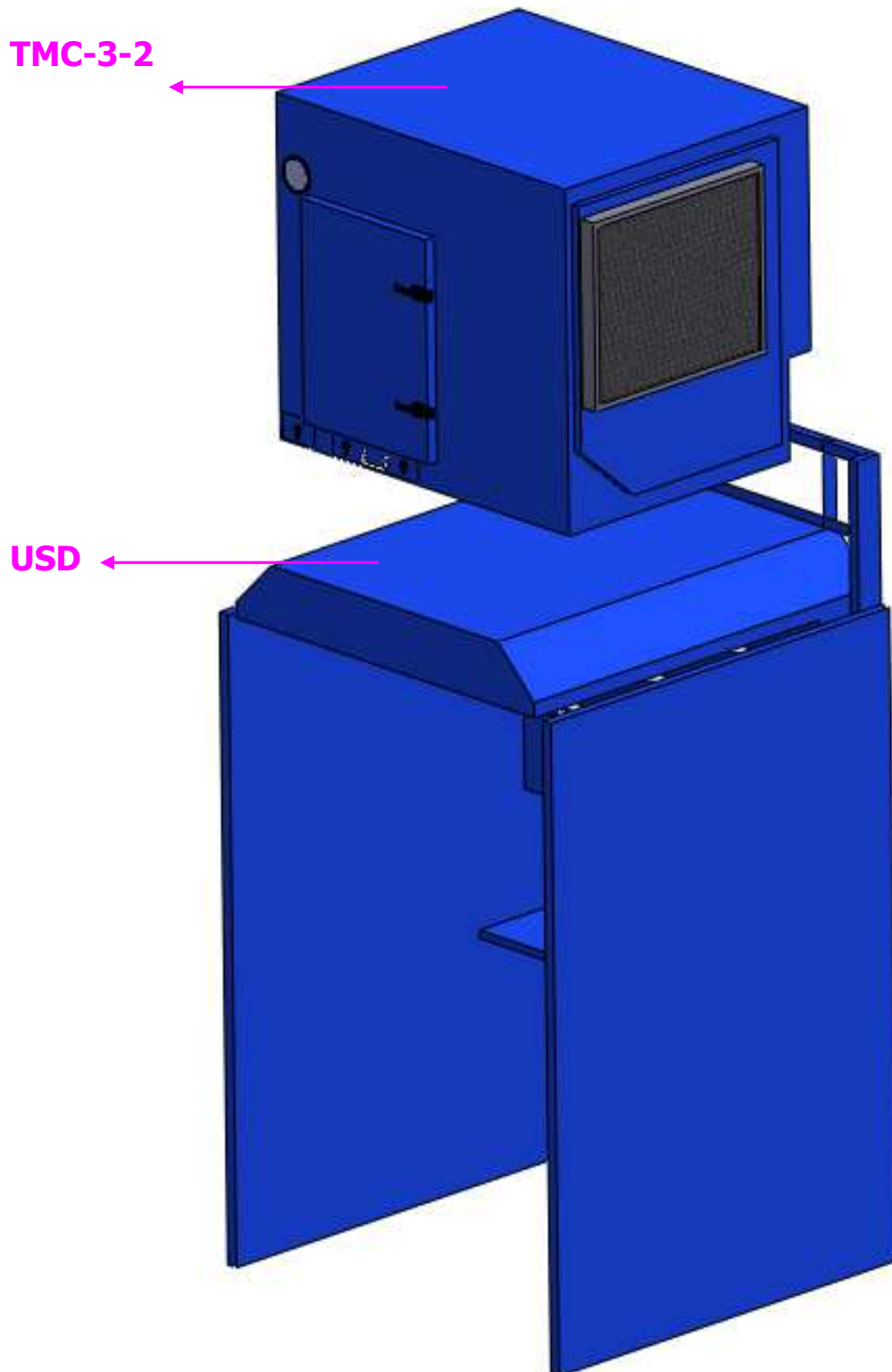

TMC-3-2 Air released hose



Insert the Air released hose into the hole, as the arrow shown.

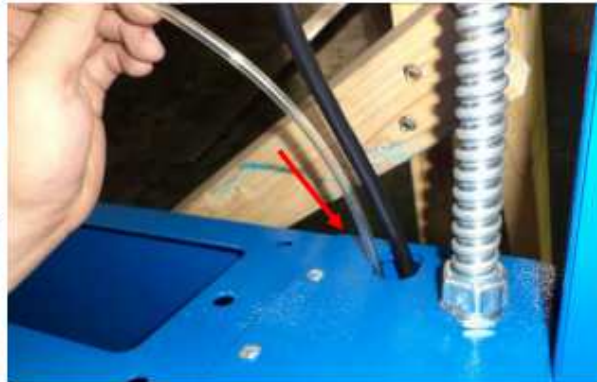

Use a screwdriver to lose the screws.



Steps to dismantle the Manual Air Pulse Jet.



Release the knob first.



Loosen the ring.



Last, take out all the parts



The manual Air Pulse Jet



Have the PU tube installed on the copper adapter.



Lock tightly with a wrench.



Motor Cable



Insert the motor cable into the iron plate as arrow shown.



Pull out one side of the left flexible tubing, as the red arrow show.



Have the motor cable pass through the hole on the iron plate.



Like the direction shown on photo.



Put cable gland through the motor cable as the red arrow shown.



Insert the motor cable into the flexible tubing.



Take off the cover then insert the motor cable through the cable gland to connect with the power box.



Motor cable

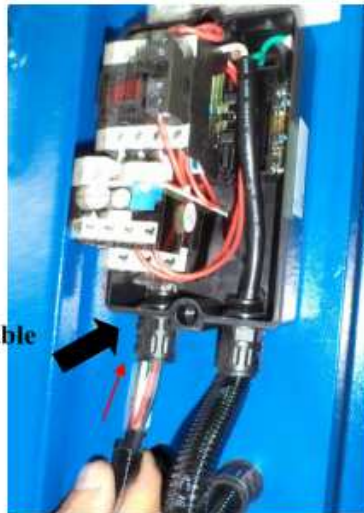

Remove the white plate first.



Join the green wire at the point as shown on photo.



Join white and black wires onto the conjunction points.

The correct diagram is like below.

Black wire **White wire** **Red wire**



Motor cable

Lock the cover of magnetic switch.



Insert the light cable into the iron plate as arrow shown.

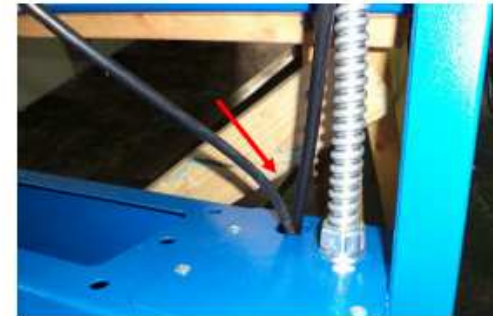

Insert the light cable into the iron plate as arrow shown.



Insert the light cable into the flexible tubing as arrow shown.



The wiring of light switch



Light cable
Join White wire in here.



Light cable
Join Black wire in here.



Light cable
Join Green wire in here.



Open the cover of the electrical conjunction box.



Follow the steps, as shown on photos, to set this device with local main power supply.

White wire

Join white wire in here (Position #4).



Black wire

Join Black wire in here (Position #5).



Green wire

Join Green wire in here (Position #2).



Close the cover of the electrical conjunction box.



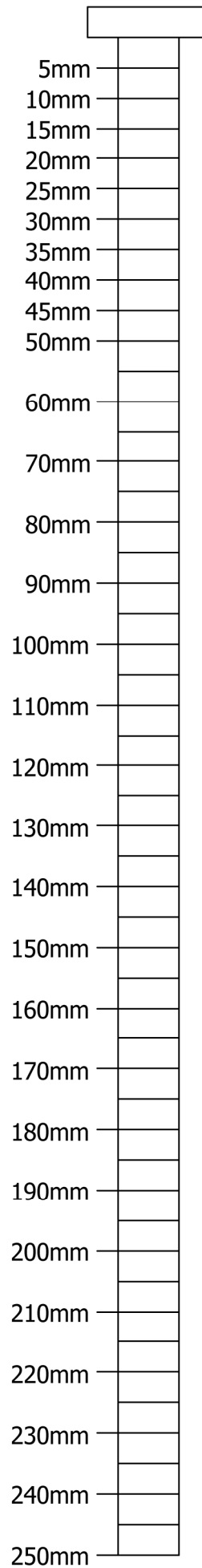
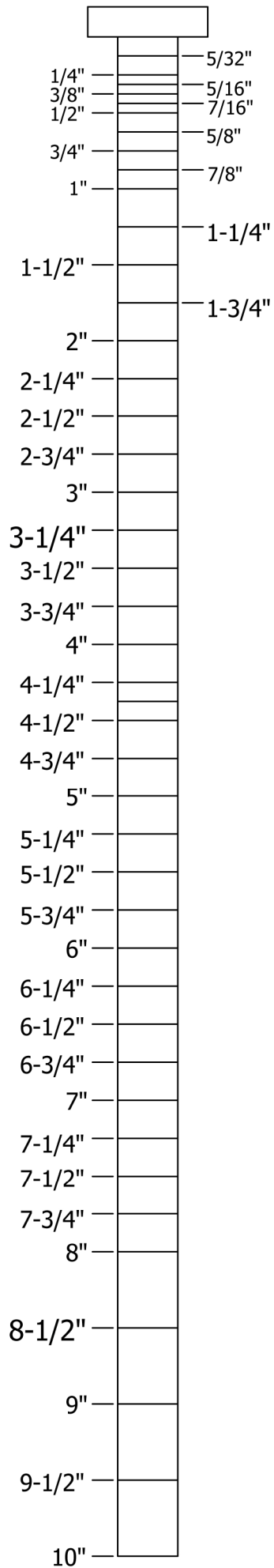

Flat Washer: 1/4"

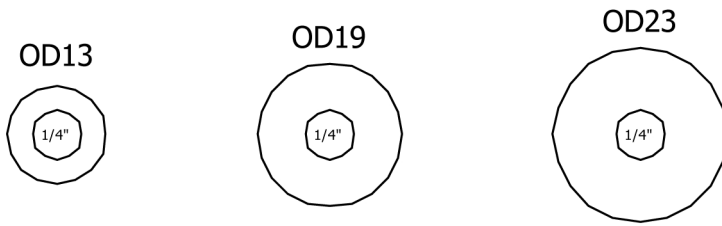

Flat Washer: 5/16"

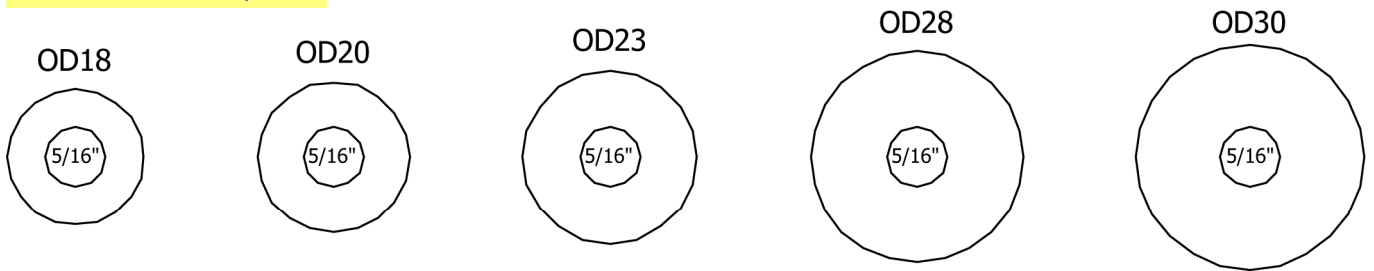

Flat Washer: 3/8"

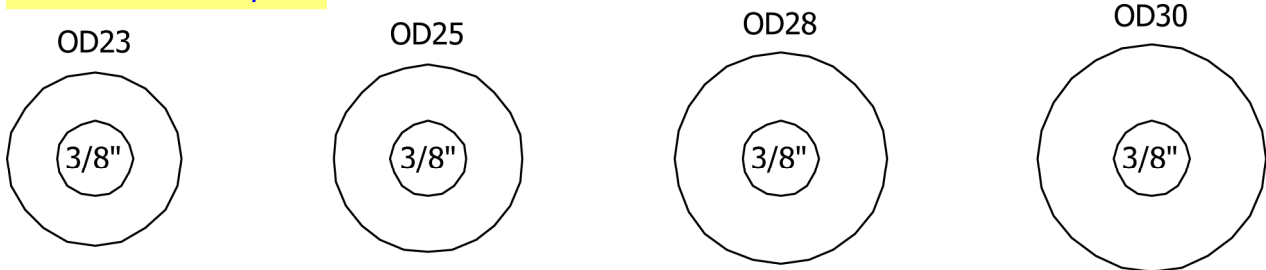

Flat Washer: 1/2"

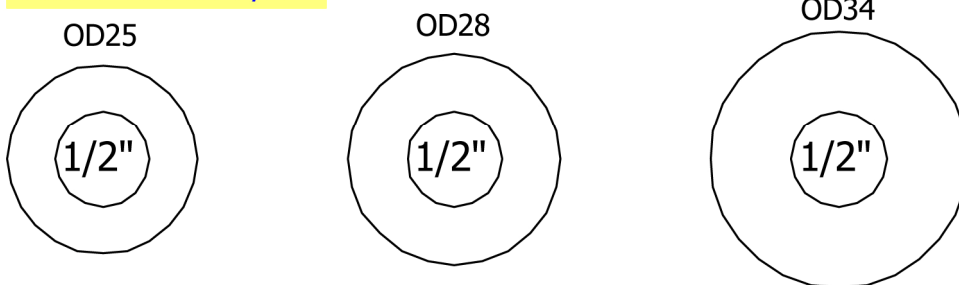

Flat Washer: 7/16"

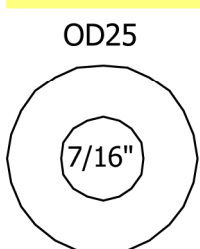

Flat Washer: 5/8"

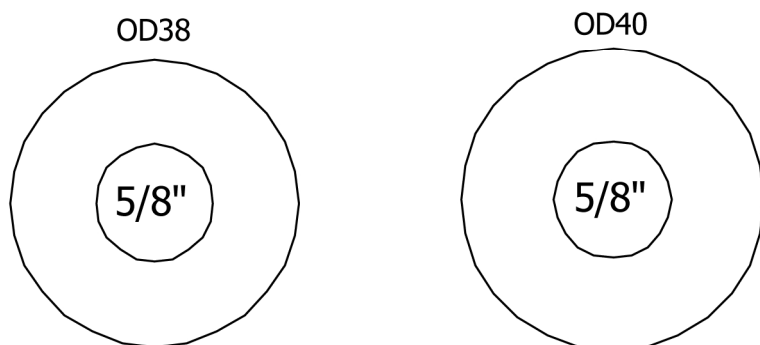

HEX NUT

3/16"



HEX NUT

1/4"



HEX NUT

5/16"

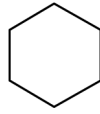

HEX NUT

3/8"

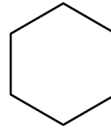

HEX NUT

1/2"

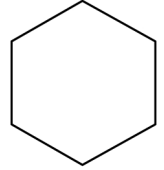

HEX NUT

NYLON HEX NUT

1/4"

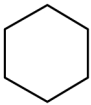

NYLON HEX NUT

5/16"

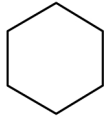

NYLON HEX NUT

3/8"

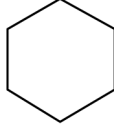

NYLON HEX NUT

1/2"

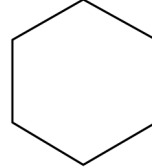

NYLON HEX NUT