

AVANI ENVIRONMENTAL INTL, INC.
 Main: (919) 570-2862 • Fax: (919) 570-2863
 www.avanienvironmental.com
 www.weldingbooths.com
 www.miststop.com
 Email: info@avanienvironmental.com

JOB _____
 SHEET NO. _____ OF _____
 CALCULATED BY _____ DATE _____
 CHECKED BY _____ DATE 11/8/10
 SCALE _____

GE

QTY - 2 pcs

Stand for ~~AMST~~ AMST
 (Weight 250 lbs)

Material: 1 1/2" Square Tubing

Plan View

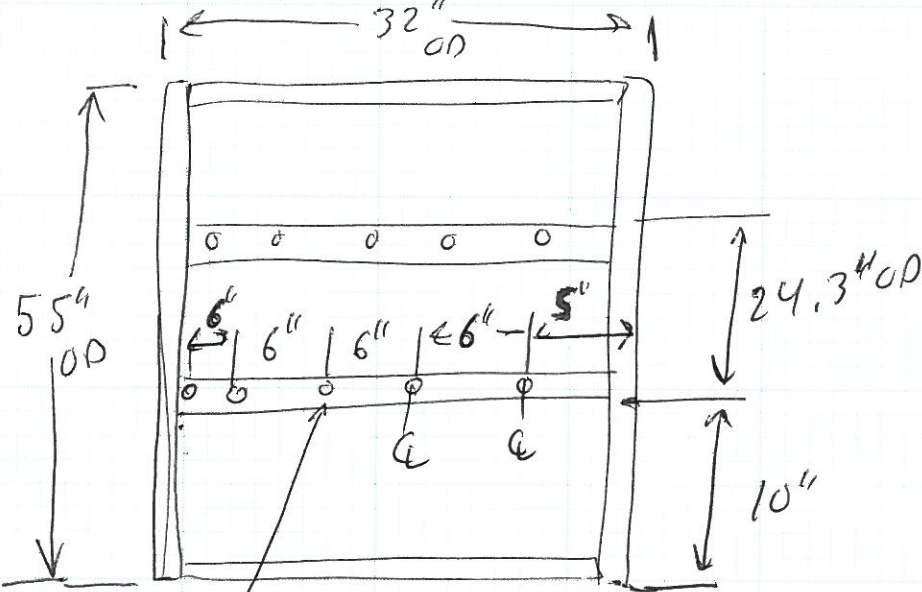

Side View

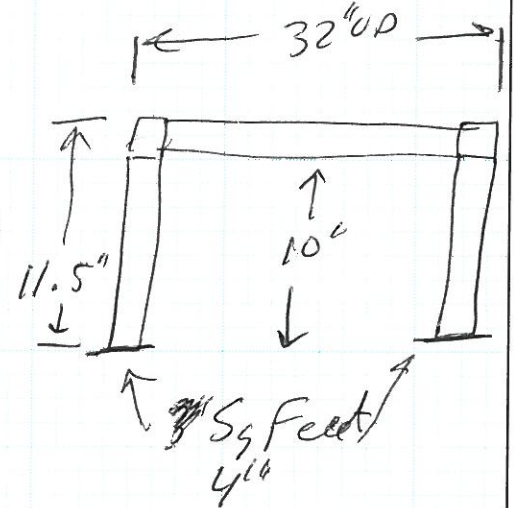

Drill 1/2" dia. Holes in Sq Tubing

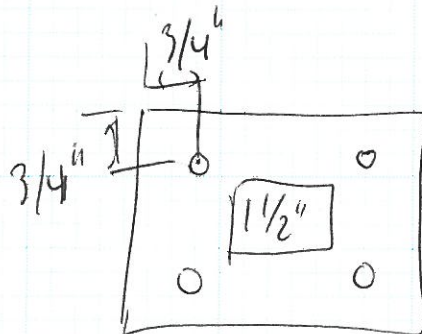

Foot Detail

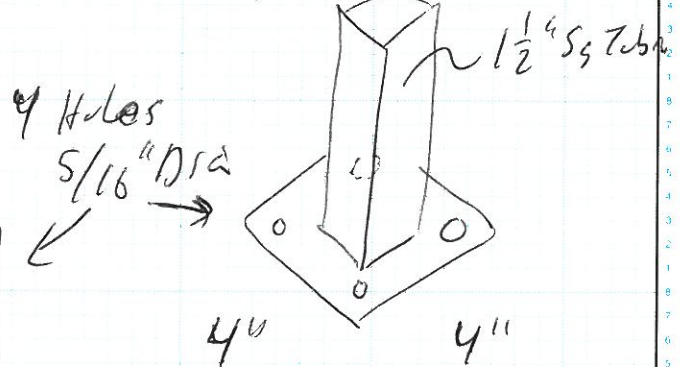

Rail Support of AMIR

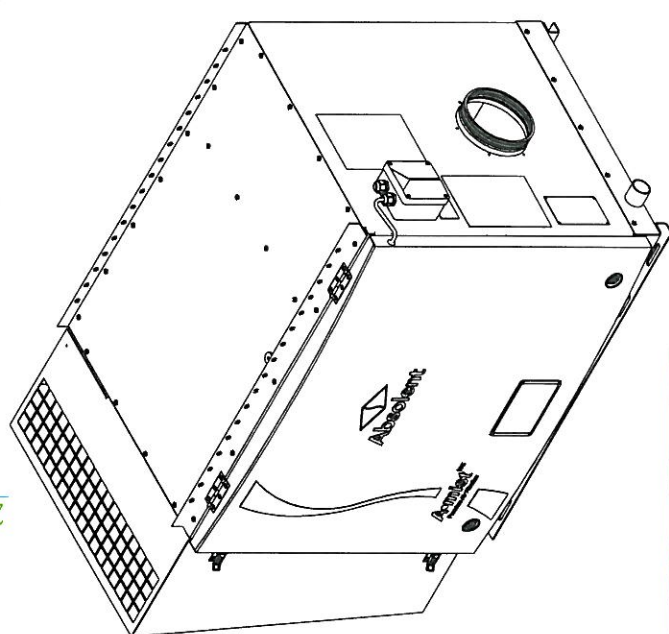
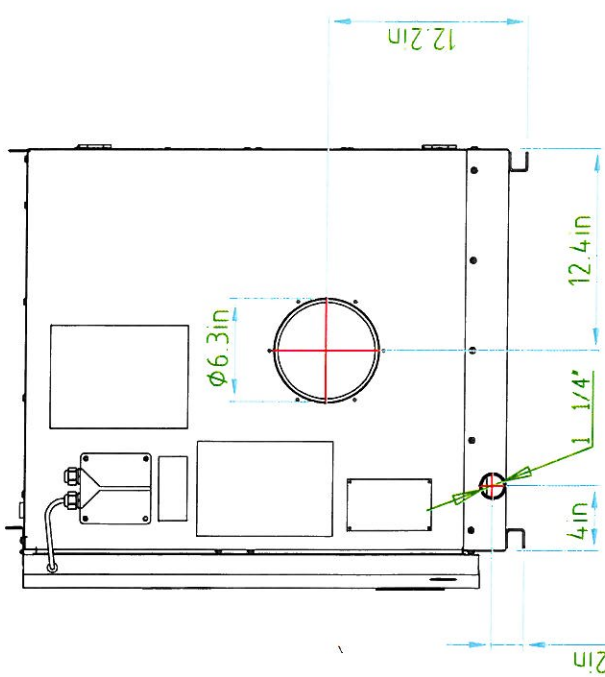
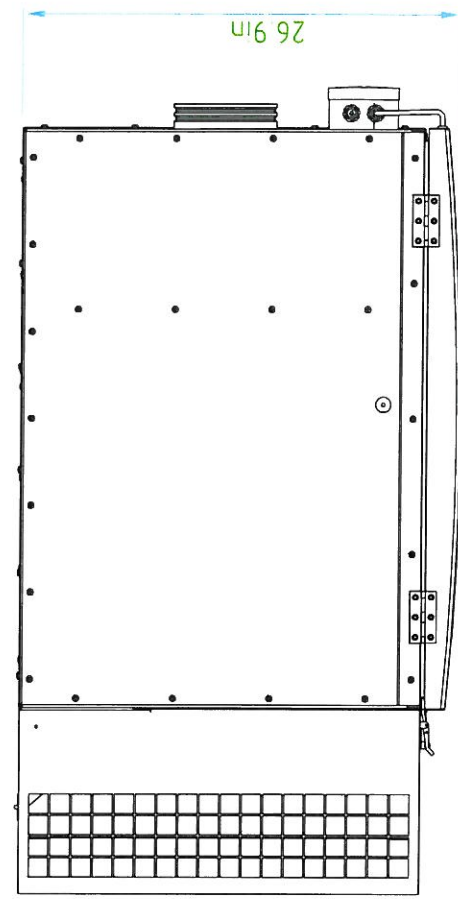
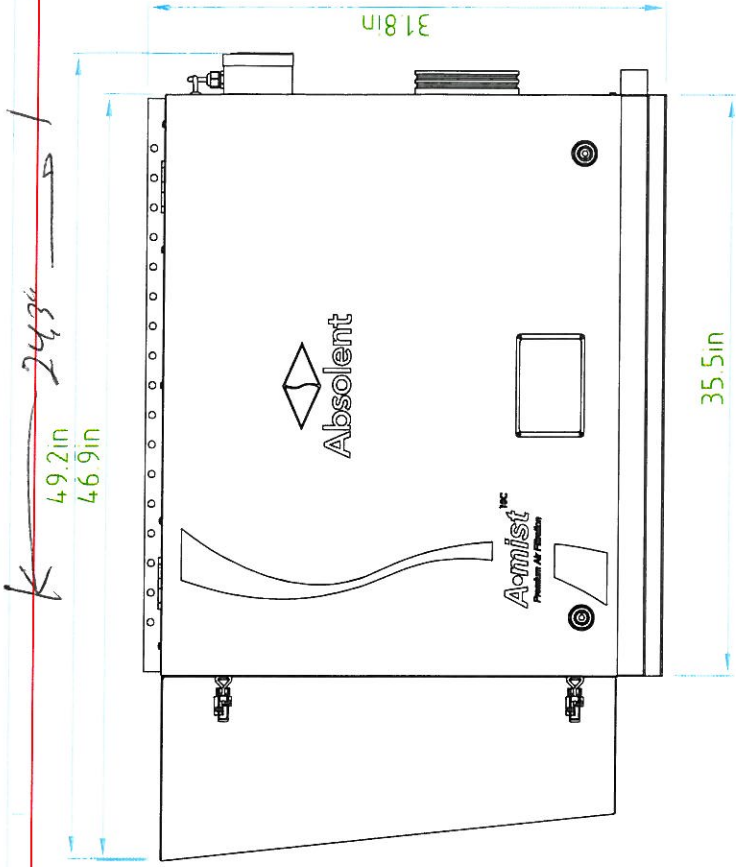
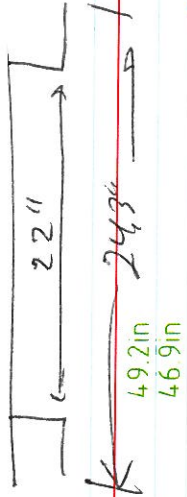

Designed by AB	Approved by JB	Project Name SS-ISO 2768- M	Projection METRIC	Scale None
A-mist 100C With Hepa Measurement			Drawing number 100423	
 Absolent AB				

This drawing not to be copied, shown or exposed without written approval by Absolent.