



Installation, Safety, Operation & Maintenance Instructions And Parts List For Models HP-Series I & II, RBE, HDBI & HDAF Arrangement 4HM Blowers.

NOTE

READ ENTIRE MANUAL INCLUDING "SECTION IV. INITIAL UNIT STARTUP" BEFORE ATTEMPTING TO INSTALL AND OPERATE THIS EQUIPMENT.

BLOWER SPECIFICATIONS

BLOWER SERIAL NUMBER: 1105072 **MFG. DATE:** 06/16/11

NOTE: The serial number above is a required reference for any assistance. It is stamped on the blower nameplate.

BLOWER SPECIFICATIONS:

Model: HDBI-220 **Arrangement:** 4HM **Rotation:** CW **Discharge:** BH

Wheel Size and Type: SQBI 55%

BLOWER PERFORMANCE DATA: (If entered on order)

CFM: 4000 **SP:** 6 (Inches of Water Gauge) **Motor BHP:** 5.61

Density: 0.075 **Altitude:** _____ (Ft. above S.L.) **Airstream Temperature:** 70 °F.

Fan RPM: 1750 **Maximum Safe Fan RPM:** 2115 @ 70°F **DO NOT EXCEED THIS RPM**

MOTOR DATA: (This section is completed only if the motor was supplied by Cincinnati Fan)

HP: 7-1/2 **RPM:** 1750 **Voltage:** 208-230/460V **Phase:** 3

Hz: 60 **Frame Size:** 213TC **Enclosure:** TEFC **Efficiency:** EPAAct Eff

IF Motor is EXP, Class(es) & Group(s) are: _____

Manufacturers Model Number: VM3710T-M8A **CFV Part Number:** 375277B

ATTENTION: RECEIVING DEPARTMENT

All Cincinnati Fan products are packaged to minimize any damage during shipment. The freight carrier is responsible for delivering all items in their original condition as received from Cincinnati Fan. The individual receiving this equipment is responsible for inspecting this unit for any obvious or concealed damage. If any damage is found, it should be noted on the bill of lading before the freight is accepted and the receiver must file a claim with the freight carrier.

LONG TERM STORAGE NOTICE

If this blower will NOT be installed and put into operation within 30 days, refer to the "Long Term Storage Instructions" on pages 12 and 13. Failure to follow all applicable long term storage instructions, will void your warranty. This blower should be stored indoors in a clean, dry location.

 **DANGER**





				
Hazardous voltage can cause electrical shock and death.	High speed rotating equipment can cause severe personal injury.	Lock out/Tag out to prevent personal injury <u>BEFORE</u> starting <u>ANY</u> service or inspection.	Avoid injury. <u>NEVER</u> operate without <u>ALL</u> required safety guards in place.	Avoid injury. You <u>MUST</u> read and understand all instructions in this manual <u>BEFORE</u> installing.

TABLE OF CONTENTS

<p>I. GENERAL</p> <p style="padding-left: 20px;">A. Unpacking and Handling2</p> <p style="padding-left: 20px;">B. Safety Accessories & Instructions2-3</p> <p>II. INSTALLATION</p> <p style="padding-left: 20px;">A. Vibration.....3</p> <p style="padding-left: 20px;">B. Mounting Methods.....3-4</p> <p style="padding-left: 20px;">C. Duct Work Connections.....4</p> <p style="padding-left: 20px;">D. Safety Guards.....4</p> <p style="padding-left: 20px;">E. Dampers and Valves.....4</p> <p style="padding-left: 20px;">F. Set Screw & Taper-lock Bushing Torque Values5</p> <p>III. ELECTRICAL</p> <p style="padding-left: 20px;">A. Disconnect Switches5</p> <p style="padding-left: 20px;">B. Motors.....5-6</p> <p style="padding-left: 20px;">C. Maximum Blower Speed.....6</p>	<p>IV. INITIAL UNIT STARTUP</p> <p style="padding-left: 20px;">A. Pre-Startup & Post-Startup Checks.....7</p> <p style="padding-left: 20px;">B. Vibration.....8-9</p> <p>V. ROUTINE INSPECTION & MAINTENANCE9</p> <p style="padding-left: 20px;">A. Hardware10</p> <p style="padding-left: 20px;">B. Motor Bearing Lubrication10</p> <p style="padding-left: 20px;">C. Wheel Balance10</p> <p style="padding-left: 20px;">D. Vibration.....10</p> <p style="padding-left: 20px;">E. Dampers and Valves.....10</p> <p style="padding-left: 20px;">F. Safety Equipment or Accessories10-11</p> <p>VI. ORDERING PARTS11</p> <p>VII. TROUBLESHOOTING11-12</p> <p>VIII. LONG TERM STORAGE12-13</p> <p>IX. WARRANTY, LIABILITY & RETURNS.....14</p> <p>X. PARTS DRAWING15</p>
---	--

I. GENERAL

A. Unpacking:

Be careful not to damage or deform any parts of the blower when removing it from the packaging container. **All the packaging material should be kept in the event the blower needs to be returned.**

Handling:

Handling of the blower should be performed by trained personnel and be consistent with all safe handling practices. Verify that all lifting equipment is in good operating condition and has the proper lifting capacity. The blower should be lifted using well-padded chains, cables or lifting straps with spreader bars. **NEVER lift the blower by an inlet or discharge flange, motor shaft, motor eye bolt, or any other part of the blower assembly that could cause distortion of the blower assembly.**

B. Safety Instructions & Accessories:

1. Safety Instructions:

All installers, operators and maintenance personnel should read AMCA Publication 410-96, “**Recommended Safety Practices for Users and Installers of Industrial and Commercial Fans**”. This manual is included with the blower. Additional copies can be requested by writing us at Cincinnati Fan, 7697 Snider Rd., Mason, OH 45040-9135

2. Sound:

Some blowers can generate sound that could be hazardous to personnel. It is the responsibility of the user to measure the sound levels of the blower and/or system, determine the degree of personnel exposure, and comply with all applicable safety laws and requirements to protect personnel from excessive noise.

3. Air Pressure and Suction:

In addition to the normal dangers of rotating machinery, the blower can present additional hazards from the suction or pressure created at the blower inlet or discharge. Suction at the blower inlet can draw materials into the blower where they become high velocity projectiles at the discharge and cause severe personal injury or death. It can also be extremely dangerous to persons in close proximity to the inlet or discharge as the forces involved can overcome the strength of most individuals.

WARNING

NEVER OPERATE A BLOWER WITH A NON-DUCTED INLET AND/OR DISCHARGE. IF THE BLOWER INLET AND/OR DISCHARGE IS NON-DUCTED, IT IS THE USERS RESPONSIBILITY TO INSTALL AN INLET AND/OR DISCHARGE GUARD.

4. Temperature:

Many blowers, blower components and all motors operate at temperatures that could burn someone if they come in contact with them. If this potential hazard could exist in your installation, steps must be taken by the user to protect anyone from coming in contact with this equipment.

5. Spark Resistance; (Per AMCA Standard 99-0401-86 and ISO 13499)

DANGER

NO GUARANTEE OF ANY LEVEL OF SPARK RESISTANCE IS IMPLIED BY SPARK RESISTANT CONSTRUCTION. IT HAS BEEN DEMONSTRATED THAT ALUMINUM IMPELLERS RUBBING ON RUSTY STEEL CAN CAUSE HIGH INTENSITY SPARKS. AIR STREAM MATERIAL AND DEBRIS OR OTHER SYSTEM FACTORS CAN ALSO CAUSE SPARKS.

6. Safety Accessories;

Guards:

All moving parts must be guarded to protect personnel. Safety requirements can vary, so the number and types of guards required to meet company, local, state and OSHA regulations must be determined and specified by the actual user or operator of the equipment.

NEVER start any blower without having all required safety guards properly installed. All blowers should be checked on a regular schedule, for missing or damaged guards. If any required guards are found to be missing or defective, the power to the blower should be immediately turned off and locked out in accordance with OSHA regulations. Power to the blower should NOT be turned back on until the required guards have been repaired or replaced.

This blower can become dangerous due to a potential "windmill" effect, even though all electrical power has been turned off or disconnected. The blower wheel should be **carefully** secured to prevent any rotational turning **BEFORE** working on any parts of the blower/motor assembly that could move.

7. Access or Inspection Doors:

DANGER

NEVER OPEN ANY ACCESS OR INSPECTION DOORS WHILE THE BLOWER IS OPERATING. SERIOUS INJURY OR DEATH COULD RESULT FROM THE AFFECTS OF AIR PRESSURE, AIR SUCTION OR MATERIAL THAT IS BEING CONVEYED. DISCONNECT OR LOCK OUT POWER TO THE BLOWER AND LET THE BLOWER WHEEL COME TO A COMPLETE STOP BEFORE OPENING ANY TYPE OF ACCESS OR INSPECTION DOOR.

II. INSTALLATION

A. Vibration:

Before any mounting method is selected, the user should be aware of the effects vibration will have on the blower, motor and other parts. Improper blower installation can cause excessive vibration causing premature wheel and/or motor bearing failure, that is not covered under warranty.

WARNING

SHUT THE BLOWER DOWN IMMEDIATELY IF THERE IS ANY SUDDEN INCREASE IN VIBRATION.

B. Mounting Methods:

An Arrangement 4HM blower is an Arrangement 4, direct driven blower without the bottom base under the motor. If the motor being supplied is a foot mounted motor, an angle base must be used to connect the blower to the motor. A C-Face motor can be bolted directly to the housing without using an angle bracket. Most Arrangement 4HM blowers are supplied with an inlet or discharge flange for mounting the blower to some type of equipment. Some are supplied with both inlet and discharge flanges.

CAUTION

In all cases where the blower flange will be the only connection with another structure, the structure **MUST** be braced enough and/or rigid enough so as not to allow a resonance vibration to occur. Some form of additional bracing under the motor, supplied and installed by the customer, might be required to maintain vibration levels below the maximum limits as indicated in Fig. 3 on page 9. If the blower has an inlet and a discharge flange, be careful not to cause “binding” when bolting them down. That will most definitely cause a vibration problem.

1. Mounting Blower By Inlet Flange only;

a. With motor shaft horizontal (parallel with floor):

If mounting the blower by the inlet flange only and with the motor shaft horizontal (parallel with floor), it is very likely additional support under the motor will be required.

b. With motor shaft vertical (perpendicular to floor):

This is the best way to mount an Arrangement 4HM blower as long as the mounting plate the flange will be bolted to is rigid enough to support the weight of the blower/motor assembly.

2. Mounting Blower By Discharge Flange only;

a. With motor shaft horizontal or vertical:

Because of the forces involved, it will most likely be necessary to add additional support under the motor. Mount the blower and take the vibration readings as shown in Fig. 2 on page 8. If they exceed the maximums shown in Fig. 3 on page 9, you will need to add additional support.

C. Duct Work Connections:

All ducting or accessories, added by the user, should be independently supported. DO NOT use the blower/motor assembly to support any additional weight. Inlet and/or discharge duct elbows should be located a minimum of 2 blower wheel diameters from the blower. Any duct elbows located closer than 2 wheel diameters to the blower inlet or discharge **WILL** reduce the air performance and blower efficiency. Any duct elbows near the blower discharge should be in the **same rotational direction** as the **blower rotation**.

Non-Ducted Blower Inlet:

Any blower with no ducting on the inlet **must** have an inlet guard. The blower should be located so the blower inlet is, at least, 1 wheel diameter away from any wall or bulkhead to eliminate a reduction in air flow.

Non-Ducted Blower Discharge:

Any blower with no ducting on the discharge **must** have a discharge guard.

D. Safety Guards:

Cincinnati Fan offers guards, as optional, to keep your blower in compliance with OSHA safety regulations. These include inlet or discharge guards. Any blowers built with high temperature construction, a “heat slinger guard” is standard. It is the responsibility of the user to make sure this blower meets all local, state and OSHA safety regulations. If you have a specific guard requirement not covered by OSHA, please contact the local Cincinnati Fan sales office for assistance.

E. Dampers and Valves: (Airflow control devices)

If the blower is supplied with any type of air flow control device, it should be closed before initial start-up of the blower to minimize overloading of the motor. Any airflow control device, with bearings, should be maintained in accordance with the manufacturers instructions. Any air flow control device, with an automatic control mechanism, should be adjusted per the manufacturers recommendations.

F. Set Screw and Taper-lock Bushing Torque Values:

All blower wheel set screws are tightened to the proper torque prior to shipment. Some wheels may have taper-lock hubs and split, taper-lock bushings to secure the wheel to the motor shaft.

NOTE: Check all set screw or taper-lock bushing torques. Forces encountered during shipment, handling, rigging and temperature can affect factory settings. For correct torque values, see **Tables 1** and **2** below.

Table 1

SET SCREW TORQUE VALUES		
Diameter & Number of Treads/Inch	Hex Wrence Size (Across Flats)	Required Torque (Inch Pounds)
1/4-20	1/8"	65
5/16-18	5/32"	165
3/8-16	3/16"	228
7/16-14	7/32"	348
1/2-13	1/4"	504
5/8-11	5/16"	1104

Table 2

TORQUE VALUES FOR TAPER-LOCK BUSHINGS	
Taper-lock Bushing Size	Required Torque (Inch Pounds)
H	95
B	192
P	192
Q	350
R	350

CAUTION

Set screws should **NEVER** be used more than once. If the set screws are loosened, they **MUST** be replaced. Use only knurled, cup-point, set screws with a nylon locking patch.

III. ELECTRICAL

A. Disconnect Switches:

All blower motors should have an independent disconnect switch located in close visual proximity to turn off the electrical service to the blower motor. **Disconnects must be locked out in accordance with OSHA "lock out-tag out" procedures any time inspection or maintenance is being performed on the blower and/or motor assembly.**

The "lock out-tag out" procedure should be performed by a licensed electrician or authorized personnel.

All disconnects should be sized in accordance with the latest NEC codes (National Electric Codes) and any local codes and should be installed only by a licensed electrician. "Slow blow" or "time delay" fuses or breakers should be used since the initial start-up time for the blower motor, although rare, can be up to 10 seconds.

B. Motors:

DANGER

ALL WIRING CONNECTIONS, INSPECTION AND MAINTENANCE OF ANY MOTOR MUST BE PERFORMED BY A LICENSED ELECTRICIAN IN ACCORDANCE WITH THE MOTOR MANUFACTURERS RECOMMENDATIONS, ALL ELECTRICAL CODES AND OSHA REGULATIONS. FAILURE TO PROPERLY INSTALL, MAKE WIRING CONNECTIONS, INSPECT OR PERFORM ANY MAINTENANCE TO A MOTOR CAN RESULT IN MOTOR FAILURE, PROPERTY DAMAGE, EXPLOSION, ELECTRICAL SHOCK AND DEATH.

- 1. DO NOT connect or operate a motor without reading the motor manufacturers instructions supplied with the blower.** The basic principle of motor maintenance is: **KEEP THE MOTOR CLEAN AND DRY.** This requires periodic inspections of the motor. The frequency of the inspections depends on the type of motor, the service and environment it will be subjected to and the motor manufacturers instructions.
- 2. Cleaning:** Cleaning should be limited to exterior surfaces only. **Follow motor manufacturers cleaning instructions.**
- 3. Lubrication:** Most small motors have sealed bearings that are permanently lubricated for the life of the motor. Some larger motors have grease plugs that should be replaced with grease fittings to perform re-lubrication. These motors, or any motor with grease fittings, should be lubricated in accordance with the motor manufacturers recommendations. Lubrication frequency depends on the motor horsepower, speed and service. **BE SURE** you use compatible grease and **DO NOT** over grease.
- 4. Location:** If the motor will be outside and subjected to the weather, it is recommended that a weather cover be installed to keep rain and snow off of the motor. No motors are guaranteed to be "watertight". Be careful to allow enough openings between the motor and the motor cover to let the motor "breathe". If the back end of the motor is covered, the cover should be no closer than 3" to the back of the motor for proper ventilation.

5. **Wiring Connections:** All wiring connections should be made for the proper voltage and phase as shown on the motor nameplate. Connections should follow the motor manufacturers recommendations as shown on the wiring schematic. This wiring diagram will be located on the outside of the motor, inside of the motor conduit box or on the motor nameplate. **Reversing some wires might be necessary to get the correct blower rotation.**
6. **Motors with Thermal Overload Protection:** If a motor is equipped with thermal overloads, the thermal overload must be wired per the wiring schematic to be operable. **There are 3 types of thermal overloads:**
- a. **Automatic:** These will automatically shut the motor down if the internal temperature exceeds the design limits.

⚠ DANGER

MAKE SURE YOU LOCK OUT THE POWER TO THE MOTOR BEFORE INSPECTING ANY MOTOR WITH AUTOMATIC THERMALS. WHEN THE THERMALS COOL DOWN, THEY WILL ALLOW THE MOTOR TO AUTOMATICALLY START UP AGAIN, UNLESS YOU HAVE LOCKED OUT THE POWER TO THE MOTOR.

- b. **Manual:** These motors will have a button on them. If the motor overheats, it will shut down. After you have inspected the motor and eliminated the over heating problem, you will need to “reset” it by pushing the button. **You should still lock out the power BEFORE inspecting the motor.**
 - c. **Thermostats:** This type of thermal is a temperature sensing device **ONLY**. If the motor overheats, the thermostats will open or close (depending on the type) and send a “signal” to the electrical box. **THEY WILL NOT TURN THE MOTOR OFF. These are pilot circuit devices that must be connected to the magnetic starter circuit.**
7. **EXPLOSION PROOF Motors:** No motor is explosion proof. Explosion proof (EXP) motors are designed so if there is an explosion **WITHIN** the motor, the explosion will be **CONTAINED INSIDE** the motor and not allowed to get out to the atmosphere. All explosion proof motors must be selected based on the atmosphere and/or the environment the motor will be operating in. Explosion proof motors are designed, rated, and labeled for their operating conditions based on Classes, Groups and “T” Codes. **The Class, Group and “T” Code of an EXP motor MUST be selected based on the atmosphere and/or environmental conditions the motor will be operating in. Consult the NEC (National Electric Code) and the NFPA (National Fire Protection Association) for the proper EXP motor Class, Group and “T” Code required for your specific application and location.**

⚠ DANGER

IF AN EXPLOSION PROOF MOTOR IS USED IN AN AREA CONTAINING VOLITILE LIQUIDS, GASES, FUMES OR DUST FOR WHICH THE MOTOR WAS NOT DESIGNED TO OPERATE IN, AN EXPLOSION AND/OR FIRE CAN OCCUR.

NOTICE:

- a. All EXP motors have some type of thermal overload as required by UL (Underwriters Laboratories). Refer to all of Section 6 above.
 - b. All EXP motors are required to have the UL (Underwriters Laboratories) and CSA (Canadian Standards Association) listing numbers on the motor name plate or on a separate plate attached to the motor. The Class, Group and “T” Code the motor is designed for must also be listed.
8. **Normal Motor Operating Temperatures:**
Using your hand to test the normal running temperature of a motor can be a very painful experience;
The normal operating temperature of a fully loaded, open type, electric motor operating in a 70°F. (21° C.) ambient temperature is 174°F. (79° C.)
- C. **Maximum Blower Speed and Motor Speed Controllers:**
If you will be using any type of motor speed controller with this blower, **DO NOT** exceed the **maximum safe blower speed**. Installing and using a speed control device requires special training and certification as required by the speed control manufacturer. See the manufacturers instructions for proper use, installation and wiring connections for the maximum speed settings. It may also be necessary to “block out” some speeds to eliminate a resonant vibration problem. The maximum safe blower speed is shown on the data sheet shipped with the blower. If you have lost the data sheet, contact Cincinnati Fan or our sales office for your area. You must have the serial number from the **blower** name plate for us to determine the maximum safe blower speed. Cincinnati Fan will only extend the motor manufacturers warranty, when used with a speed controlling device, if the motor has the words “**Inverter Duty**” marked on the motor name plate. If the motor does not have “**Inverter Duty**” marked on the motor name plate, and you have a motor failure, you will be required to contact the motor manufacturer for any service or warranty claims.

IV. INITIAL UNIT STARTUP

NOTICE: Failure to complete and document all the following pre-startup and both post-startup checks, listed in sections A (below) and B on page 8, could void all warranties.

A. Pre-Startup & Post-Startup Checks: (Check blocks as each step is completed. Retain this for your records.)

A1. Pre-Startup Checks Completed By: _____ DATE: _____
 A2. 8 Hour, Post-Startup Checks Completed By: _____ DATE: _____
 A3. 3 Day, Post-Startup Checks Completed By: _____ DATE: _____

MAKE SURE POWER TO THE MOTOR IS LOCKED OUT BEFORE STARTING PRE-STARTUP OR POST-STARTUP CHECKS.

1. If possible, *CAREFULLY* spin the blower wheel by hand to ensure it rotates freely and no rubbing or clicking noise is heard.
2. Check all blower mounting flange and duct work hardware to make sure it is tight.
3. Check all blower wheel set screws to make sure they are tight per **Table 1** on page 5.
4. If the wheel has a taper-lock bushing, make sure the bolts are tightened per **Table 2** on page 5.
5. Make certain there is no foreign material in the blower or duct work that can become a projectile.
6. Make sure any inspection doors in the duct work are securely bolted or locked.
7. Ensure all electrical power components are properly sized and matched for your electrical system.
8. Check that all required guards are properly secured.
9. Any dampers should be fully opened and closed to make sure there is no binding or interference.
10. If your blower is mounted on an elevated support structure, make sure the structure is welded at all the joint connections and the structure is properly braced to prevent "side sway".
11. Close any dampers to minimize load on motor. Especially on blowers with high temperature construction. **Never** subject a "cold" blower to a "hot" gas stream. If the blower will be handling "hot gases" greater than 150°F (65°C) it is imperative that the blower be subjected to a gradual rate of temperature increase, not to exceed 15°F/minute (8°C/minute). The same temperature limits are also important when the blower is experiencing a drop in temperature until the temperature drops down to 150°F (65°C). Only, when the entire blower has reached an equilibrium temperature of 150°F (65°C), or less, should the power be turned off.
12. Make sure the power source connections to the blower motor are per the motor manufacturers instructions.
13. Make sure the blower wheel is stationary prior to startup. **Starting a blower with a wheel that is rotating backwards can cause wheel damage.**
14. Apply power to the blower motor momentarily (i.e. "bump start") to check for proper blower wheel rotation. If the blower is rotating in the wrong direction, reconnect the motor leads per the motor manufacturers wiring schematic. **Blower rotation is determined by viewing the blower from the motor side of the blower, NOT from the inlet side.** After reconnecting the leads, repeat this step. **See Fig. 1 below.**

Fig. 1

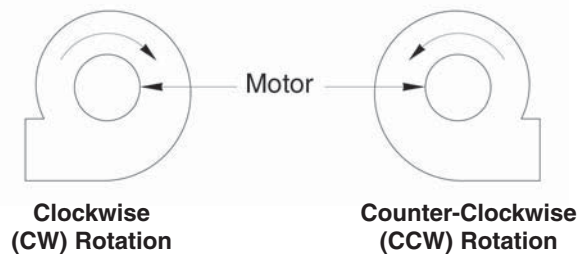

15. Apply power to the blower motor and let it come up to full speed. **Turn off the power.** Look and listen for any unusual noise or mechanical abnormality while the blower wheel is still spinning. If any are noticed, lock out the power, wait for the blower wheel to come to a complete stop, locate the cause and correct it.
16. Unlock power and start the blower.
17. Measure, record and keep the following motor data for future reference and comparison:
(Single phase motors will only have L1 and L2 leads)

Amperage draw on each motor lead: L1 _____ L2 _____ L3 _____

(Running amps **SHOULD NOT** exceed the motor nameplate amps for the voltage being operated on)

Voltage coming to motor leads: L1 _____ L2 _____ L3 _____

(Should be about the same input voltage on all leads)

B. Vibration:

The blower was balanced at the factory to comply with ANSI/AMCA Standard 204-05, Category BV-3. However, rough handling in shipment and/or erection, weak and/or non-rigid foundations, and misalignment may cause a vibration problem after installation. After installation, the vibration levels should be checked by personnel experienced with vibration analysis and vibration analysis equipment.

NOTE:

The blower **SHOULD NOT** be operated if the vibration velocity of the fan exceeds 0.40 inches per second, filter out, with the blower rigidly mounted.

Vibration readings for direct driven blowers should be taken on the motor at the top, sides and end as per **Fig. 2** below. After you have taken your vibration readings, write them down in the spaces below and keep for future comparison.

⚠ DANGER

If the blower is going to be conveying material, it is the users responsibility to periodically turn the blower off and lock out the power. The blower wheel should then be checked for material build-up and/or erosion. If material has built up on any parts of the wheel, it **MUST** be removed and cleaned before it is put back into service. If any parts of the wheel have been eroded, the wheel **MUST** be replaced. Failure to perform this inspection can cause excessive vibration that will damage the blower and/or motor bearings. When vibration becomes excessive, it will lead to complete blower failure that could cause property damage, severe personal injury and death. The user must determine the frequency of this inspection based on the actual circumstances of their operation, **BUT** checking the vibration readings should **NEVER** exceed a 12 month period. For the AMCA/ANSI standard for vibration limits, see Fig. 3 on page 9.

Fig. 2

VIBRATION METER PROBE POSITIONS				
For Arrangement 4HM Blowers				
1	2	3	4	5

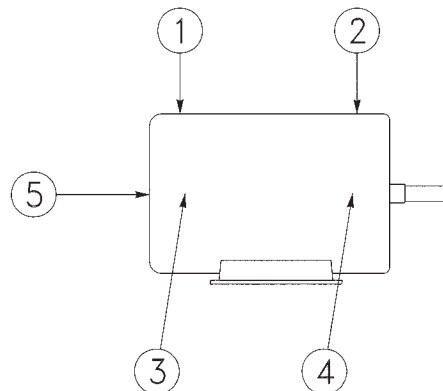

A					
B					
C					

A Pre-Startup	Readings taken by: _____	Date: _____
B 8 Hour Post-Startup	Readings taken by: _____	Date: _____
C 3 Day Post-Startup	Readings taken by: _____	Date: _____

Fig. 3 Vibration Severity Chart

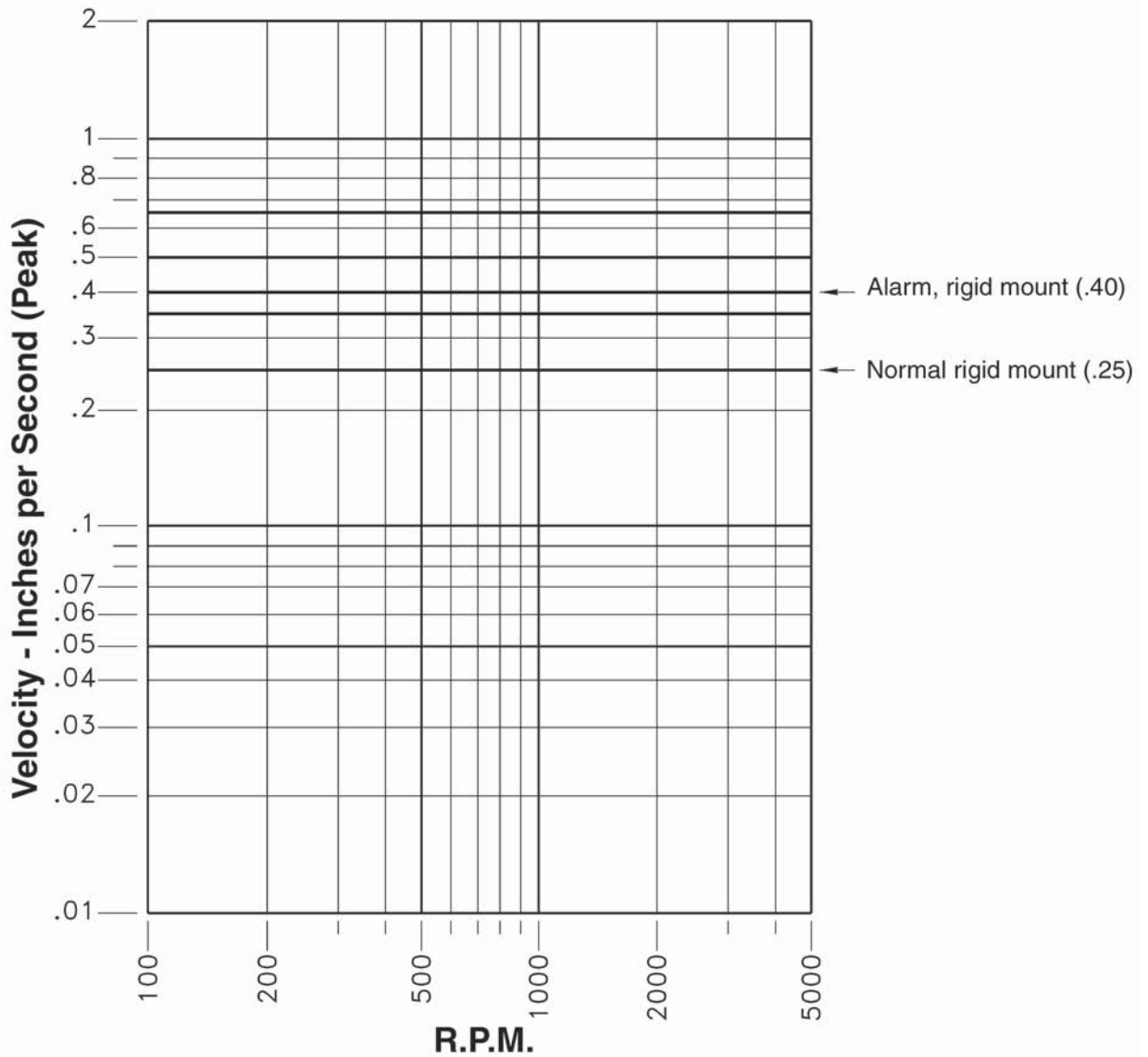

V. ROUTINE INSPECTION & MAINTENANCE

Periodic inspection of all the blower parts is the key to good maintenance and trouble-free operation. The frequency of inspections must be determined by the user and is dependent upon the severity of the application. **BUT**, it should **NEVER** exceed a 12 month period. The user should prepare an inspection and maintenance schedule and make sure it is adhered to.

⚠ WARNING

BEFORE STARTING ANY INSPECTION OR MAINTENANCE, BE SURE BLOWER IS TURNED OFF, POWER IS LOCKED OUT AND THE BLOWER WHEEL HAS BEEN CAREFULLY SECURED TO PREVENT WIND MILLING. IF THE OPERATING CONDITIONS OF THE BLOWER ARE TO BE CHANGED (SPEED, PRESSURE, TEMPERATURE, ETC.) CONSULT CINCINNATI FAN, OR OUR SALES OFFICE FOR YOUR TERRITORY, TO DETERMINE IF THE UNIT WILL OPERATE SAFELY AT THE NEW CONDITIONS.

A. Hardware:

All blower and foundation hardware should be checked to make sure it is tight. Wheel set screws or taper-lock bushings should be tightened to the torque values shown in **Tables 1 and 2** on page 5.

NOTE: If any set screws have come loose, they must be thrown away and replaced. **NEVER** use set screws more than once. **Replace with knurled, cup-point set screws with a nylon locking patch.**

B. Motor Bearing Lubrication:

1. Motor Bearings:

Most smaller motors have sealed bearings that never require re-lubrication for the life of the motor. For any motors with grease fittings, consult the motor manufacturers recommendations with reference to the lubrication frequency and the type of grease that should be used.

DO NOT over grease the motor bearings. Generally, 1-2 shots should be enough. Use a hand operated grease gun at no more than 40 PSI. ***IF POSSIBLE, CAREFULLY*** lubricate the motor bearings while the motor is running.

C. Wheel Balance:

All blower wheels are balanced at the factory. It is not uncommon that additional “trim balancing” is required after the blower is assembled. Trim balancing of the blower assembly, in the field, is typically always necessary for all replacement wheels. **After any wheel is installed, the final balance of the entire blower assembly should be checked.** Refer to **Section B** on page 8 and **Fig. 3** on page 9. Air stream material or chemicals can cause abrasion or corrosion of the blower parts. This wear is generally uneven and, over time, will lead to the wheel becoming unbalanced, causing excessive vibration. When that happens, the wheel must be rebalanced or replaced. The other air stream components should also be inspected for wear or structural damage and cleaned or replaced if necessary. **After cleaning any blower wheel, it should be balanced and then “trim balanced” on the motor shaft.**

There are two ways to balance a blower wheel:

1. Add balancing weights for fabricated aluminum, steel or stainless steel wheels:

Balance weights should be rigidly attached to the wheel at a location that will not interfere with the blower housing nor disrupt air flow. They should (if at all possible) be welded to the wheel. When trim balancing the wheel, **on the blower**, be sure to ground the welder **directly** to the blower wheel. Otherwise, the welding current will likely pass through the motor and damage the motor bearings.

2. Grinding off material for cast aluminum wheels:

If you are grinding on the wheel to remove material, be very careful not to grind too much in one area. That could affect the structural integrity of the wheel.

NOTE:

Removing any Backward Inclined or Airfoil wheel from the blower to clean it requires special attention when reinstalling the wheel back into the blower housing. Make sure you reinstall the wheel so the proper wheel-to-inlet clearance is maintained. Failure to do this will affect the blowers airflow (CFM), static pressure (SP) capabilities and efficiency. Consult Cincinnati Fan or our local sales office for your area for assistance if necessary.

D. Vibration:

As mentioned previously in this manual, excessive vibration can cause premature motor bearing failure that could lead to catastrophic failure of the blower. After performing any routine maintenance, the vibration readings should be taken again. New readings should be taken (maximum every 12 months) and compared to the readings you recorded in **Fig. 2** on page 8, during the initial startup. **If any major differences are present, the cause should be determined and corrected before the blower is put back into operation.**

The most common causes of vibration problems are:

1. Wheel unbalance.
2. Mechanical looseness.
3. Poor blower inlet and/or discharge conditions.
4. Foundation stiffness.

E. Dampers and Valves: (Airflow control devices)

Turn off and lock out power to the blower motor. Any dampers or valves should be periodically inspected to make sure all parts are still operable within their full range and there is no interference with any other damper or blower components. Any bearings or seals should be checked for their proper function. The manufacturers maintenance instructions should be followed.

F. Safety Equipment & Accessories:

It is the users responsibility to make sure that all safety guards required by the company, local, state and OSHA regulations are properly attached and fully functional at all times. If any guards become defective or non-functional at any time, **the power to the blower MUST be turned off and locked out** until complete repairs and/or replacements have been made, installed and inspected by authorized personnel.

Any accessories used in conjunction with the blower should also be inspected to make sure they are functioning within their intended limits and design specifications. The manufacturers maintenance manuals should be referred to for correct maintenance procedures. These accessories include, but are not limited to, the following:

Shaft seals, inspection doors, vibration isolators or vibration bases, air flow or pressure measuring equipment, hoods, controls, special coatings, silencers, expansion joints, valves, flexible connectors and filters.

VI. ORDERING REPLACEMENT PARTS:

Under normal conditions, you should not need any spare or replacement parts for at least 24 months after shipment from Cincinnati Fan. That does not include any wear due to abrasion, corrosion, excessive temperatures, abuse, misuse, accident or any severe conditions the fan was not designed for.

NOTICE:

1. **If this blower is vital to any process that could cost you lost revenue, we strongly recommend that you keep a replacement blower wheel and motor at your location.**
2. **If this blower is vital for the safety of any people and/or animals, we strongly recommend that you keep a complete blower/motor assembly, as originally ordered, at your location.**

To order any parts or complete units, contact us for the name of our sales office for your area. Or you can find them on our website at: www.cincinnati-fan.com

WE MUST HAVE THE BLOWER SERIAL NUMBER FROM THE BLOWER NAME PLATE TO IDENTIFY PARTS CORRECTLY.

VII. TROUBLESHOOTING

DANGER

Troubleshooting should only be performed by trained personnel. Any potential electrical problems should only be checked by a licensed electrician. All safety rules, regulations and procedures MUST be followed. Failure to follow proper procedures can cause property damage, severe bodily injury and death.

Potential problems and causes listed below are in no order of importance or priority. The causes are only a list of the most common items to check to correct a problem. If you find the cause of a problem, **DO NOT** assume it is the **ONLY** cause of that problem. Different problems can have the same causes.

PROBLEM	CAUSE
Excessive Vibration	<ol style="list-style-type: none"> 1. Loose mounting bolts, wheel set screws, taper-lock hubs. 2. Worn or corroded blower wheel. 3. Accumulation of foreign material on blower wheel. 4. Bent motor shaft. 5. Worn motor bearings. 6. Motor out of balance. 7. Inadequate structural support. 8. Support structure not sufficiently cross braced. 9. Weak or resonant foundation.
Airflow (CFM) Too Low	<ol style="list-style-type: none"> 1. Blower wheel turning in wrong direction (rotation). 2. Actual system static pressure (SP) is higher than expected. 3. Motor speed (RPM) too low. 4. Dampers or valves not adjusted properly. 5. Leaks or obstructions in duct work. 6. Filters dirty. 7. Inlet and/or discharge guards are clogged. 8. Duct elbow too close to blower inlet and/or discharge. 9. Improperly designed duct work 10. Blower wheel not properly located relative to the inlet bell (Models HDBI and HDAF only).
Airflow (CFM) Too High	<ol style="list-style-type: none"> 1. Actual system static pressure (SP) is lower than expected. 2. Motor speed (RPM) too high. 3. Filter not in place. 4. Dampers or valves not adjusted properly.

PROBLEM	CAUSE
Motor Overheating	<p>NOTE: A normal motor will operate at 174°F. See B-8 on page 6.</p> <ol style="list-style-type: none"> 1. Actual system static pressure (SP) is lower than expected. 2. Voltage supplied to motor is too high or too low. 3. Motor speed (RPM) too high or defective motor. 4. Air density higher than expected. 5. Motor wired incorrectly or loose wiring connections. 6. Cooling fan cover on back of motor is clogged. (Fan cooled motors only.)
Excessive Noise	<ol style="list-style-type: none"> 1. Wheel rubbing inside of housing. 2. Worn or corroded blower wheel. 3. Accumulation of foreign material on blower wheel. 4. Loose mounting bolts, wheel set screws, or taper-lock hubs. 5. Bent motor shaft. 6. Worn motor bearings. 7. Motor out of balance. 8. Motor bearings need lubrication. 9. Vibration originating elsewhere in system. 10. System resonance or pulsation. 11. Inadequate or faulty design of blower support structure. 12. Blower operating near “stall” condition due to incorrect system design or installation.
Fan Doesn't Operate	<ol style="list-style-type: none"> 1. Motor wired incorrectly. 2. Incorrect voltage supply. 3. Defective fuses or circuit breakers. 4. Power turned off elsewhere. 5. Motor wired incorrectly or loose wiring connections. 6. Defective motor.

VIII. LONG TERM STORAGE INSTRUCTIONS: (Storage exceeding 30 days after receipt of equipment)

NOTE: Failure to adhere to these instructions voids all warranties in their entirety.

1. Storage site selection:
 - a. Level, well-drained, firm surface, in clean, dry and warm location. Minimum temperature of 50°F (10°C).
 - b. Isolated from possibility of physical damage from construction vehicles, erection equipment, etc.
 - c. Accessible for periodical inspection and maintenance.
2. The blower should be supported under each corner of its base to allow it to “breathe”. Supports (2 x 4's, timbers, or railroad ties) should be placed diagonally under each corner.
3. If the equipment is to be stored for more than three (3) months, the entire blower assembly must be loosely covered with plastic, **but not tightly wrapped**.
4. Storage Maintenance:

A periodic inspection and maintenance log, by date and action taken, must be developed and maintained for each blower. See example below. Each item must be checked monthly.

EXAMPLE:

Storage / Maintenance Schedule Log

ITEM	ACTION	DATES CHECKED
1	Re-inspect units to insure any protective devices used are functioning properly. Check for scratches in the finish which will allow corrosion or rust to form.	
2	Rotate wheel a minimum of 10 full revolutions to keep the motor bearing grease from separating and drying out. <i>This is a critical step.</i>	

Long Term Storage instructions continued on page 13.

5. General Motor Procedure:

If the motor is not put into service immediately, the motor must be stored in a clean, dry, warm location. Minimum temperature of 50°F. (10°C,). Several precautionary steps must be performed to avoid motor damage during storage.

- a. Use a "Megger" each month to ensure that integrity of the winding insulation has been maintained. Record the Megger readings. Immediately investigate any significant drop in insulation resistance.
- b. **DO NOT** lubricate the motor bearings during storage. Motor bearings are packed with grease at the factory.
- c. If the storage location is damp or humid, the motor windings **must** be protected from moisture. This can be done by applying power to the motor's space heaters, (IF AVAILABLE) while the motor is in storage. If the motor does not have space heaters, storing it in a damp or humid location will, very quickly, cause internal corrosion and motor failure which is not warranted.

NOTE:

For specific storage instructions, for the actual motor and any accessory parts that were supplied, refer to the manufacturer's instructions.

IX. LIMITED WARRANTY:

Cincinnati Fan & Ventilator Company (Seller) warrants products of its own manufacture, against defects of material and workmanship under normal use and service for a period of eighteen (18) months from date of shipment or twelve (12) months from date of installation, whichever occurs first. This warranty does not apply to any of Seller's products or any part thereof which has been subject to extraordinary wear and tear, improper installation, accident, abuse, misuse, overloading, negligence or alteration. This warranty does not cover systems or materials not of Seller's manufacture. On products furnished by Seller, but manufactured by others, such as motors, Seller extends the same warranty as Seller received from the manufacturer thereof. Expenses incurred by Purchaser's in repairing or replacing any defective product will not be allowed except where authorized in writing and signed by an officer of the Seller.

The obligation of the Seller under this warranty shall be limited to repairing or replacing F.O.B. the Seller's plant, or allowing credit at Seller's option. **THIS WARRANTY IS EXPRESSLY IN LIEU OF ALL OTHER WARRANTIES EITHER EXPRESSED OR IMPLIED INCLUDING THE WARRANTIES OF MERCHANTABILITY AND FITNESS FOR A PARTICULAR PURPOSE AND OF ALL OTHER OBLIGATIONS AND LIABILITIES OF THE SELLER. THE PURCHASER ACKNOWLEDGES THAT NO OTHER REPRESENTATIONS WERE MADE TO PURCHASER OR RELIED UPON BY PURCHASER WITH RESPECT TO THE QUALITY OR FUNCTION OF THE PRODUCTS HEREIN SOLD.**

Removal of the Seller's nameplate or any generic fan nameplate containing the fan serial number voids all warranties, either written or implied. Failure to complete and document all the pre-startup and post startup checks and perform the suggested routine maintenance checks voids all warranties, either written or implied.

LIMITATION OF LIABILITY:

Notice of any claim, including a claim for defect in material or workmanship, must be given to Seller in writing within 30 days after receipt of the equipment or other products. Seller reserves the right to inspect any alleged defect at Purchaser's facility before any claim can be allowed and before adjustment, credit, allowance replacement or return will be authorized. See **RETURNS** below. Seller's liability with respect to such defects will be limited to the replacement, free of charge, of parts returned at Purchaser's expense F.O.B. Seller's plant and found to be defective by the Seller.

IN NO EVENT WILL SELLER BE LIABLE FOR SPECIAL, INDIRECT, INCIDENTAL OR CONSEQUENTIAL DAMAGES, WHETHER IN CONTRACT, TORT, NEGLIGENCE, STRICT LIABILITY OR OTHERWISE, INCLUDING WITHOUT LIMITATION DAMAGES FOR INJURY TO PERSONS OR PROPERTY, LOST PROFITS OR REVENUE, LOST SALES OR LOSS OF USE OF ANY PRODUCT SOLD HEREUNDER. PURCHASER'S SOLE AND EXCLUSIVE REMEDY AGAINST SELLER WILL BE THE REPLACEMENT OF DEFECTIVE PARTS AS PROVIDED HEREIN OR REFUND OF THE PURCHASE PRICE FOR DEFECTIVE PRODUCTS, AT SELLER'S SOLE OPTION. SELLER'S LIABILITY ON ANY CLAIM, WHETHER IN CONTRACT, TORT, NEGLIGENCE, STRICT LIABILITY OR OTHERWISE, FOR ANY LOSS OR DAMAGE ARISING OUT OF OR IN CONNECTION WITH PURCHASER'S ORDER OR THE PRODUCTS OR EQUIPMENT PURCHASED HEREUNDER, SHALL IN NO CASE EXCEED THE PURCHASE PRICE OF THE EQUIPMENT GIVING RISE TO THE CLAIM.

RESPONSIBILITY:

It is the understanding of the Seller that Purchaser and/or User will use this equipment in conjunction with additional equipment or accessories to comply with all Federal, State and local regulations. The Seller assumes no responsibility for the Purchaser's or Users compliance with any Federal, State and local regulations.

RETURNS:

Cincinnati Fan & Ventilator Company assumes no responsibility for any material returned to our plant without our permission. An **RMA** (Return Material Authorization) number must be obtained and clearly shown on the outside of the carton or crate and on a packing slip. Any items returned must be shipped freight prepaid. Failure to comply will result in refusal of the shipment at our receiving department.

DISCLAIMER

This manual, and all its content herein, is based on all applicable known material at the time this manual was created. **Any parts of this manual are subject to change at any time and without notice.**

If any statements, diagrams and/or instructions contained herein, **for components not manufactured by the Seller**, conflict with instructions in the manufacturer's manual (i.e.: motors, dampers, etc.), the instructions in the manufacturer's manual, for that component take precedent.

Should you want the latest version of this manual, please contact us or our sales office for your area. Or, you can print a current version by going to our website at: www.cincinnati-fan.com



7697 Snider Road, Mason, OH 45040-9135
Phone: (513) 573-0600 Fax: (513) 573-0640
E-Mail: sales@cincinnati-fan.com

1. MOTOR
2. PLUG BASE, FAN
3. BLOWER WHEEL
4. HOUSING
5. INLET BELL
6. INLET SPOOL PIECE

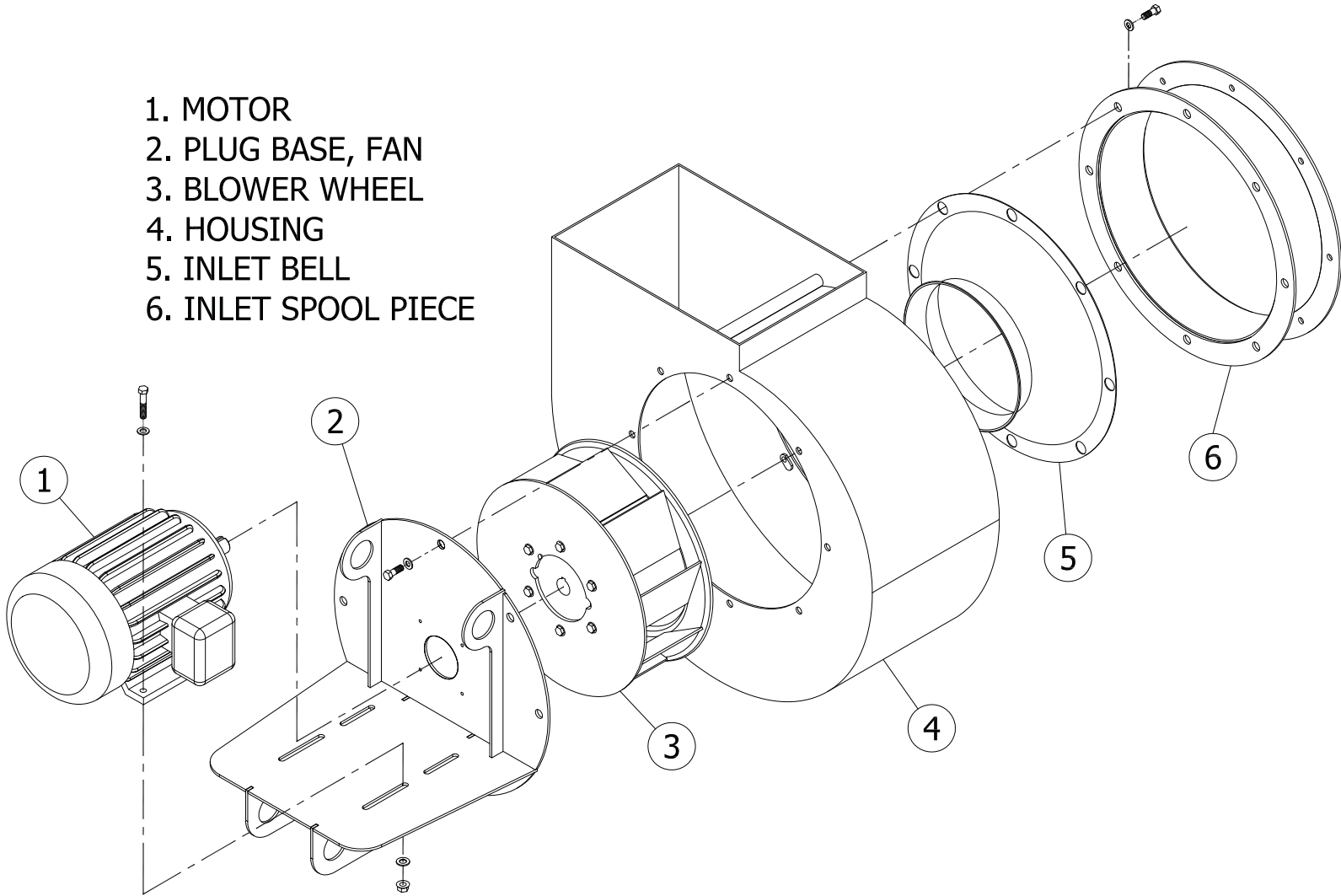

HDBI & HDAF ARRANGEMENT 4HM

The drawing shown above is a representation of the basic model blower or fan purchased on the serial number shown on page 1. It does not include any optional or accessory parts or any special construction features that might have been supplied with the original order.