

| Rev | Description | Date | Approved |
|-----|-------------|------|----------|
| | | | |

Revisions

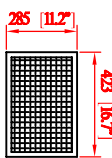

x2 ps
End View - Front of Unit as Installed

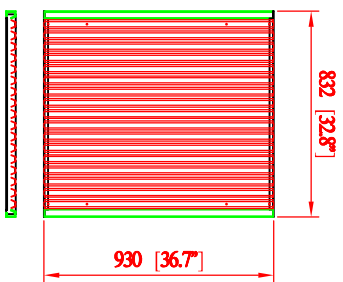
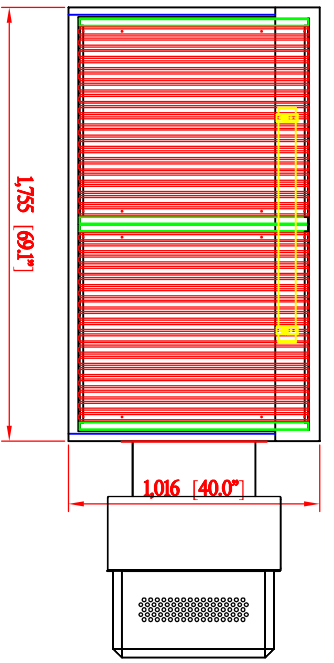
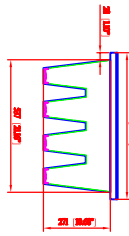

End View - Side of Unit as Installed

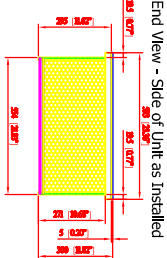

End View - Side of Unit as Installed

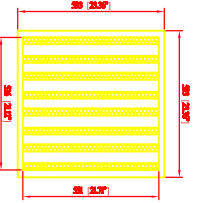

SDT-7.5C DOWNDRAFT TABLE SPECIFICATIONS

- Motor: 7.5HP
- ***NEMA Motor
- ***Aluminum Impeller
- Electric Spec: 230/460V / 60Hz / 3Ph (wired at 460V)
can be rewired in **ONE** voltage:
either:
230V / 60Hz / 3Ph / 8.6A (wired at 230V)
or
460V / 60Hz / 3Ph / 4.3A (wired at 460V)
- Airflow: 3000 CFM (5094 m3/hr)

Filtration Stages:

1. aluminum mesh x 2 pcs
- spec: 285 x 423 x 22mm (11.3" x 16.7" x 0.87")
2. Cartridge Filter: DIA. 283 x 330mmL x 6 pcs
- spec: dia. 283 x 330mmL (dia. 11.2" x 13")
- filtering area: 5m² x 6 = 30m² (322.91 ft²)
- Material: Polyester with TEFLOn treatment & coating.

- No. of Valves: 1
- Compressed Air Requirement: 90 PSI
- Compressed Air Reservoir: 2.7 gallon
- Dimension: 71.9" x 43.7" x 70.6"
(1824.5 x 1109.1 x 1791.6mm)
- Construction: 14 gauge steel
- Max. Operating Temp.: 120°C
- Paint Color: powder coated Blue
- UL control box
- Manual Air Pulse Jet
- Electrical Outlets: (2) 110V Outlets @ (1) Switch
- Light Switch: For overhead lights
- ***Overhead Lights: (1) Working Lights (110V, Single Phase, 60 Hz, 20W)

****Design options:**

1. 100% downdraft with no side/back panels
 2. 100% downdraft with (2)side (1) back panels(Shown in drawing)
 3. 80%/20% with (2) side panels
- ***no blower outlet to reduce noise
 - ***table top with grated surface
 - ** gauge hole pre-drilled.
 - Optional HEPA filter shown.

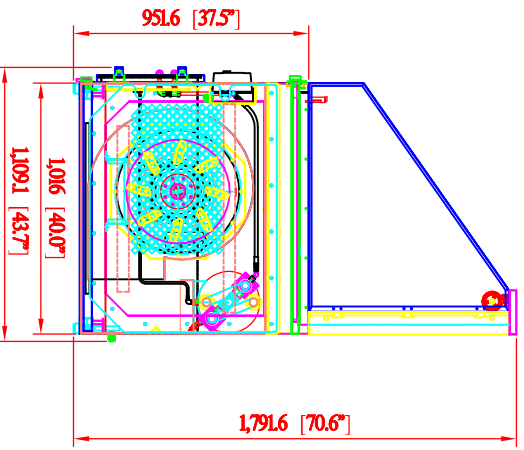
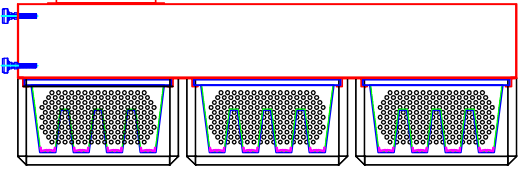
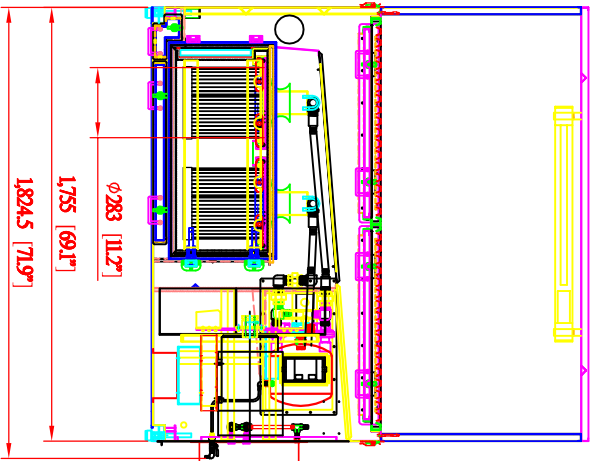

PRELIMINARY

AVANI ENVIRONMENTAL INTL. INC. Sales Department
95 Cypress Drive
Youngsville, NC 27596
(919) 570-2862
info@avanienvironmental.com

| Date | Name | Part Number: | Title: |
|------------|------|--------------|--------------------------|
| 2015-05-06 | *** | REVISION A | SDT-7.5C Downdraft table |
| | | | |

The drawings, AutoCAD, 3-D Models, and specifications are the property of Avani Environmental Intl. Inc. (A/E) and may not be reproduced, distributed, modified, or otherwise used, except provided herein, without the express written permission of A/E.

Size Scale Drawing Number:
B 1 = 25 GALA SDT-7.5C
Page 1 of 1