

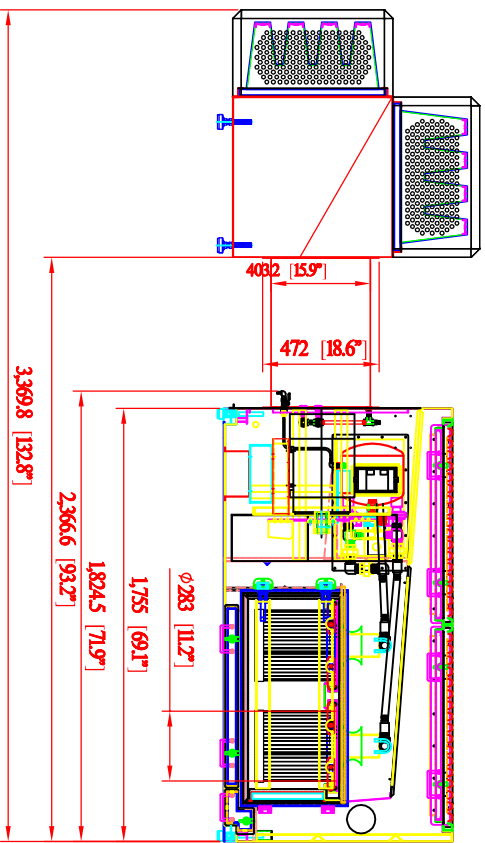

Plan View

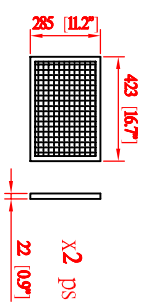
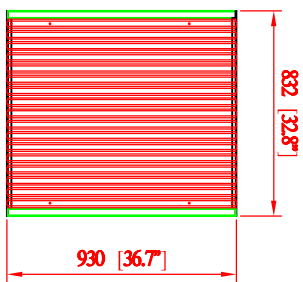
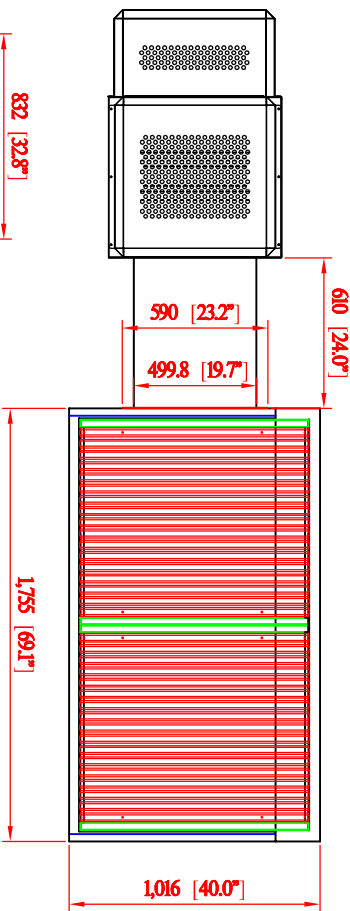
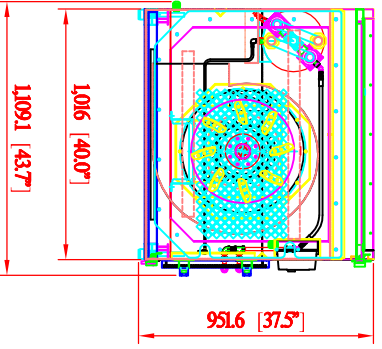
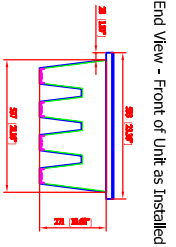
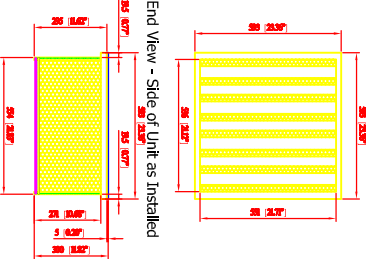

**SDT-7.5L DOWNDRAFT TABLE SPECIFICATIONS**

- Motor: 7.5HP
- \*\*\*NEMA Motor
- \*\*\*Aluminum Impeller
- Electric Spec: 230/460V / 60Hz / 3Ph (wired at 460V)  
can be prewired in **ONE** voltage:  
either:  
230V / 60Hz / 3Ph / 8.6A (wired at 230V)  
or  
460V / 60Hz / 3Ph / 4.3A (wired at 460V)
- Airflow: 3000 CFM (5094 m3/hr)

**Filtration Stages:**

1. aluminum mesh x 2 pcs  
- spec: 285 x 423 x 22mm (11.3" x 16.7" x 0.87")
2. Cartridge Filter: DIA. 283 x 330mmL x 6 pcs  
- spec: dia. 283 x 330mmL (dia. 11.2" x 13")  
- filtering area: 5m2 x 6 = 30m2 (322.91 ft2)  
- Material: Polyester with TEFLON treatment & coating.

- No. of Valves: 1
- Compressed Air Requirement: 90 PSI
- Compressed Air Reservoir: 2.7 gallon
- Dimension: 71.9" x 43.7" x 70.6"  
(1824.5 x 1109.1 x 1791.6mm)
- Construction: 14 gauge steel
- Max. Operating Temp.: 120°C
- Paint Color: powder coated Blue
- UL control box
- Manual Air Pulse Jet
- \*\*\*100% downdraft with no side/back panels
- \*\*\*no blower outlet to reduce noise
- \*\*\*table top with grated surface
- \*\* gauge hole pre-drilled.
- Optional HEPA filter available.

PRELIMINARY

Rev	Description	Date	Approved

AVANI ENVIRONMENTAL INTL. INC. Sales Department 95 Cypress Drive Youngsville, NC 27596 (919) 570-2862 info@avanienvironmental.com		Date: 2015.05.21 Name: *** Part Number: REVISION G Title: SDT-7.5L	The drawings, AutoCAD, 3-D Models, and specifications are the property of Avani Environmental Intl. Inc. (AE) and may not be reproduced, distributed, modified, or otherwise used, except provided herein, without the express written permission of AE.	Size: F Scale: 1 = 25 Drawing Number: Gala SDT-7.5L Page 1 of 1
---	--	---	--	--