

20" Jacob Tubing Plenum Box
 For A*Mist 80TF
 Medtronic's

TOP VIEW

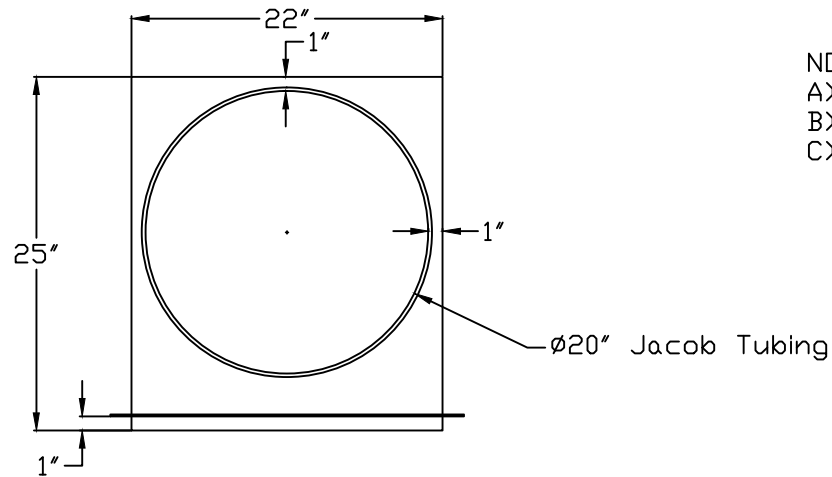

- NOTES:
 A) MATERIAL: 18 GA. GALV.
 B) ALL SEAMS WELDED
 C) Use standard bolt hole pattern with 7/16" Holes

SIDE VIEW

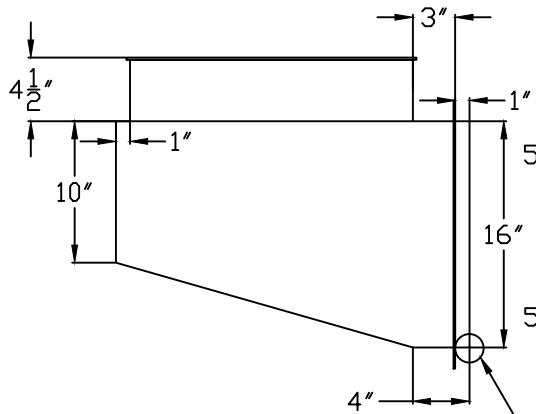

END VIEW

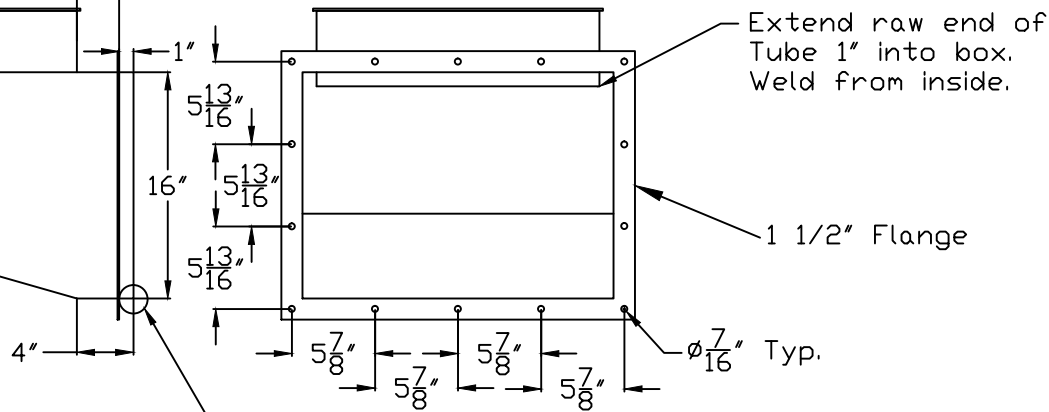

NOTE: WELD ALL CORNERS ON BOTTOM INSIDE THE PLENUM!!!!

Avani Environmental Intl. 95 Cypress Drive Youngsville, NC 27596 P# 919-570-2862 F# 919-570-2863		Avani
Project: Medtronics		
Drawing: 20" Plenum Box		
Date: 4/2/15	Drawn by: WWB	
Sheet No: 1 of 1	Rev.: A	